

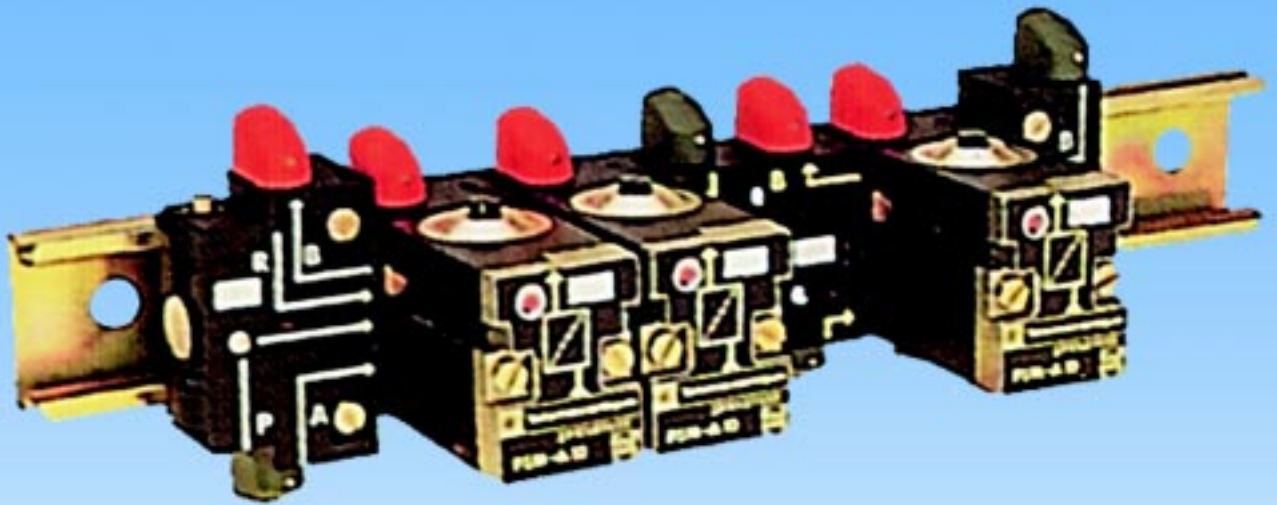

# Logic Processing

*Modular sequencer, inline/modular  
logic elements, bus mounted elements,  
relays, electrical operators,  
impulse-counters, timers*



- Complete range
- Stand alone or stackable and combinable modules
- Very fast response time
- Visual indicator
- Flexible and highly maintainable system
- DIN rail mounting

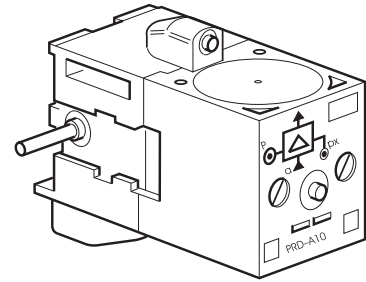

## Operating information

Working pressure	3 to 8 bar
Working temperature	-15 °C to 60 °C
Flow (acc. ISO 6358)	General Qmax=180 NI/min PRD Qmax=90 NI/min PRS Qmax=60 NI/min

## Step modules

Type	Symbol	Logic function	Description	Swivel push-in* connection	Weight Kg	Order code	D
		Visual indication of pneumatic output and manual override	With PSB-A12 subbase	Ø4 mm	0,175	<b>PSM-A12</b>	1
		Without manual override	With PSB-A12 subbase	Ø4 mm	0,170	<b>PSM-B12</b>	3



## Set of head and tail modules

Type	Symbol	Logic function	Swivel push-in* connection	Weight Kg	Order code	D
		Ø6 mm push-in swivel connection	Ø4 mm	0,080	<b>PSE-A12</b>	1

## Deviation modules

Type	Symbol	Logic function	Swivel push-in* connection	Weight Kg	Order code	D
		Used for parallel-, optional-, repeat sequenses and skip step	Ø4 mm	0,050	<b>PSD-A12</b>	1
		for the remote reset of the last step module		0,050	<b>PSD-B12</b>	3

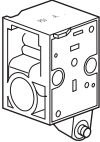

## Additional step module interlock

Type	Symbol	Logic function	Swivel push-in* connection	Weight Kg	Order code	D
		May be mounted between the subbase and the step module to interrupt the sequence if a sensor is found to be faulty	Ø4 mm	0,045	<b>PSV-A12</b>	3

\* For other type of connections contact Technical Sales Department

## Step module without subbase

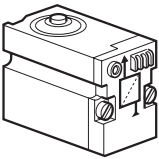
To be used with PSB-A12 subbases



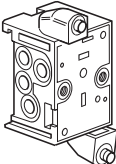

Type	Symbol	Logic function	Description	Weight Kg	Order code	D
			Visual indication of pneumatic output	0,135	<b>PSM-A10</b>	1
			Without manual override	0,130	<b>PSM-B10</b>	3

## Step module subbase



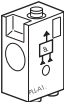

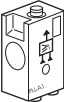

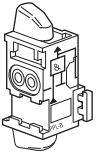

Type	Description	Swivel push-in* connection	Weight Kg	Order code	D
	Subbase	Ø4 mm	0,040	<b>PSB-A12</b>	1

\* For other type of connections contact technical sales Technical Sales Department

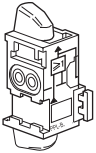

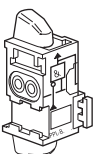

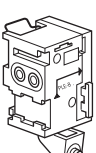

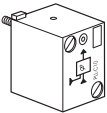

## Main data for Line mounted elements

Type	Symbol	Logic function	Description	Connection*	Weight Kg	Order code	D
		AND	Single module	Ø4 mm Straight push-in	0,07	<b>PLL-A11</b>	1
		OR	Single module	Ø4 mm Straight push-in	0,07	<b>PLK-A11</b>	1
		Screw and clip assembly	Enables line mounted logic elements to be attached to DIN rail (Sold per pack of 10)		0,02	<b>PZM-L199</b>	1

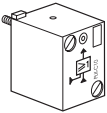
## Main data for Combinable elements

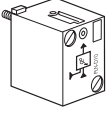

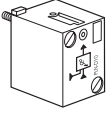



Type	Symbol	Logic function	Description	Connection*	Weight Kg	Order code	D
		AND	With built-in key for combination and operating mode selection	Ø4mm Swivel push-in	0,08	<b>PLL-B12</b>	1
		OR	With built-in key for combination and operating mode selection	Ø4mm Swivel push-in	0,08	<b>PLK-B12</b>	1
		NOT	With built-in key for combination and operating mode selection	Ø4mm Swivel push-in	0,08	<b>PLN-B12</b>	1
		INPUT	With built-in key for combination, clip for mounting on DIN rail and blankingplate for closing a bank of combined elements	Ø4mm swivel push-in	0,08	<b>PLE-B12</b>	1

## Main data for Subbase mounted elements

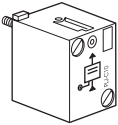
Type	Symbol	Logic function	Description	Connection*	Weight Kg	Order code	D
(For use with 3 port subbase, type PZU•• please see page 3-4)							
		AND	With visual indication of pneumatic output signal		0,03	<b>PLL-C10</b>	1
		OR	With visual indication of pneumatic output signal		0,03	<b>PLK-C10</b>	1
		NOT inhibit standard	With visual indication of pneumatic input/output signal		0,03	<b>PLN-C10</b>	1
		NOT inhibit threshold	With visual indication of pneumatic input/output signal		0,03	<b>PLN-D10</b>	1

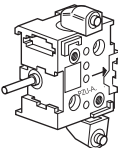
\* For other type of connections contact Technical Sales Department

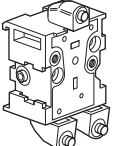

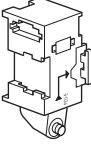

## Subbase mounted elements

Type	Symbol	Logic function	Description	Connection*	Weight Kg	Order code	D
<b>For subbase PZU**</b>							
		YES regenerate	With visual indication of pneumatic input/output signal		0,03	<b>PLJ-C10</b>	1
<b>3-port subbases**</b>							
			With common input	Ø4 mm Swivel push-in	0,04	<b>PZU-A12</b>	1
			Cascade	Ø4 mm Swivel push-in	0,05	<b>PZU-C12</b>	1
<b>4-port subbases**</b>							
			For combination with memory relay (see page 3-5) and amplifier relay (see page 3-5)	Ø4 mm Swivel push-in	0,05	<b>PZU-B12</b>	1
<b>Input module</b>							
				Ø4 mm Swivel push-in	0,05	<b>PZU-E12</b>	1

\* For other type of connections contact Technical Sales Department

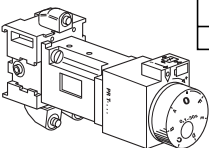
\*\* Can be used singly or in combination. Mounting methods: On DIN rail with built in clip, on surface mounting using screws M4x25

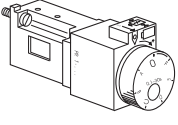



## Main data for time delay relays

Type	Function	Timing range	Connection *	Weight Kg	Order code	D	
<b>Complete with Subbase PZU-A12</b>							
		Output after timed period	0,1 to 30 s	Ø4 mm Swivel push-in	0,17	<b>PRT-A12</b>	
<b>Without subbase</b>							
For subbase PZU-A12 or PZU-C12							
		Output after	0,1 to 3 s	0,1 to 30 s	0,13	<b>PRT-E10</b>	
			timed period			0,13	<b>PRT-A10</b>
		Output during	0,1 to 3 s	0,13	<b>PRT-F10</b>	1	
		timed period **	0,1 to 30 s	0,13	<b>PRT-C10</b>	1	
		10 to 180 s	0,13	<b>PRT-D10</b>	1		
<b>Tamper proof cap</b>					0,01	<b>LA9-D901</b>	3



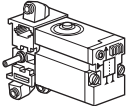

\* For other type of connections contact Technical Sales Department

\*\* Can be used to provide an impulse generator

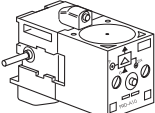

**Main data for Memory relays**

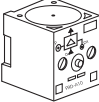
Type	Symbol	Description	Connection*	Weight Kg	Order code	D
<b>Complete with subbase PZU-B12</b> 		With priority reset signal and visual indication With manual override	Ø4 mm Swivel push-in	0,19	<b>PLM-A12</b>	1
<b>Without subbase</b> For subbase PZU-B12 		With priority reset signal and visual indication With manual override		0,14	<b>PLM-A10</b>	1
		Without manual override		0,13	<b>PLM-B10</b>	1

**Main data for Amplifier relays**

Type	Symbol	Description	Connection*	Weight Kg	Order code	D
<b>Complete with subbase PZU-B12</b> 		This relay is used to amplify the low pressure signal provided by a fluidic proximity sensor to a useable level With manual override	Ø4 mm Swivel push-in	0,18	<b>PRD-A12</b>	3
<b>Without subbase</b> For subbase PZU-B12 		This relay is used to amplify the low pressure signal provided by a fluidic proximity sensor to a useable level With manual override		0,13	<b>PRD-A10</b>	1

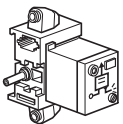
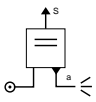
**Main data for Sensor relays**

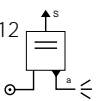
Type	Symbol	Description	Connection*	Weight Kg	Order code	D
<b>Complete with subbase PZU-A12</b> 		This relay is used to supply a bleed sensor and to generate a pneumatic signal equal to its supply pressure	Ø4 mm Swivel push-in	0,07	<b>PRF-A12</b>	3
<b>Without subbase</b> For subbase PZU-A12 or PZU-C12 		This relay is used to supply a bleed sensor and to generate a pneumatic signal equal to its supply pressure		0,03	<b>PRF-A10</b>	1

\* For other type of connections contact your Technical Sales Department



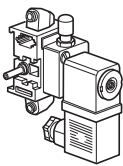
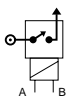
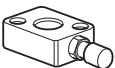
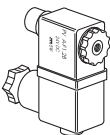



## Main data for Solenoid actuators

Type	Symbol	Voltage	Load	Connection	Weight Kg	Order code	D
<b>Complete units, solenoid and cable plug</b>							
		24 V ~ 50/60 Hz	8,5 VA	Manual override	22 mm Plug-in	0,17	<b>PRS-A121B</b> 3
		24 V	6 W	Manual override	22 mm Plug-in	0,17	<b>PRS-A122B</b> 3
		115 V ~ 50 Hz 120 V ~ 60 Hz	8,5 VA	Manual override	22 mm Plug-in	0,17	<b>PRS-A121F</b> 3
		230 V ~ 50 Hz 240 V ~ 60 Hz	8,5 VA	Manual override	22 mm Plug-in	0,17	<b>PRS-A121M</b> 1
<b>Solenoid mounting base</b>							
		For mounting the solenoid coil and plunger on 3-port modular subbases type PZU-A••, see page 3-4		Manual override		0,09	<b>PRS-D10</b> 1
<b>Solenoid coil</b>							
with plunger and 22 mm plug-in connector **  		24 V*	6 W			0,135	<b>PVA-F102B</b> 1
		48 V*	6 W			0,135	<b>PVA-F102E</b> 3
		24 V~ 50/60 Hz	8,5 VA			0,135	<b>PVA-F101B</b> 1
		48 V~ 50/60 Hz	8,5 VA			0,135	<b>PVA-F101E</b> 3
		115 V~ 50 Hz/ 120 V~ 60 Hz	8,5 VA			0,135	<b>PVA-F101F</b> 1
		230 V~ 50 Hz	8,5 VA			0,135	<b>PVA-F101M</b> 1
		240 V~ 60 Hz 255 V~ 50 Hz	8,5 VA			0,135	<b>PVA-F101U</b> 3

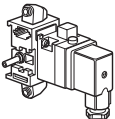
\* Versions available for operation in explosive atmospheres.  
 - Conforming to certificate LCIE 866115X  
 - Electrical equipment conforming to harmonised European standards

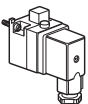
EN 50014 dated March 1977 (NFC 23514 dated May 1982)  
 EN 50019 dated March 1977 (NFC 23519 dated May 1982)  
 - Referencing code EExe II T4 (consult Technical Sales Department)  
 \*\* Can be fitted with LED indicator and suppression, PVA•ZF••

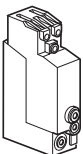
## Main data for Pressure switches

Type	Symbol	Electrical characteristics	Pneumatic characteristics	Connection Electric/Pneumatic	Weight Kg	Order code	D
<b>Complete unit with subbase, solenoid and cable plug</b>							
		N/O contact		Manual override	22 mm Plug-in Ø4 mm Swivel push-in	0,13	<b>PRE-A12</b> 1
<b>Without subbase</b>							
		N/O contact		Manual override	22 mm Plug-in Ø4 mm Swivel push-in	0,04	<b>PRE-A10</b> 1
<b>Line mounted</b>							
		1 CO contact 5 A/250 V	Fixed operating threshold	Manual override	Ø4 mm Push-in	0,05	<b>PS1-P1081</b> 1
		1 CO contact 5 A/250 V	Adjustable operating threshold	Manual override	Ø4 mm Push-in	0,05	<b>PS1-P1091</b> 1

## Main data for Impulse counters

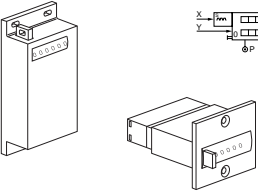
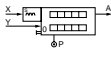
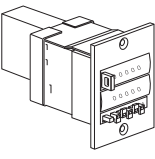
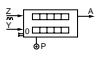
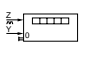
Type	Symbol	Type	Counting range	Mounting	Weight Kg	Order code	D
<b>Totalising counters</b>							
		Pneumatic or manual reset	0 - 999 999	Surface mounting	0,08	<b>PCT-A11</b>	3
				Flush mounting	0,06	<b>PCT-B11</b>	3
<b>Pre-selection counters</b>							
		Additional with pneumatic or manual reset	0 - 99 999	Flush mounting	0,12	<b>PCP-A11</b>	3
		Auto reset	0 - 99 999	Flush mounting		<b>PCP-A111</b>	3
			Subtraction with pneumatic or manual reset	0 - 99 999	Flush mounting	0,11	<b>PCP-S11</b>

## Main data for Timers

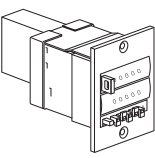
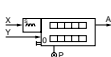
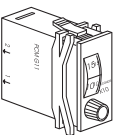
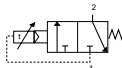
Type	Symbol	Type	Time base	Time range	Weight Kg	Order code	D
<b>Digital display</b>							
		With pneumatic or manual reset	1 second	1 second to 27 hours	0,20	<b>PCM-A11</b>	3
			1 minute	1 minute to 69 days	0,20	<b>PCM-B11</b>	3
			2 minute	3 to 100 minutes	0,20	<b>PCM-E11</b>	3
<b>Calibrated dial</b>							
			1 second	2 to 30 seconds	0,05	<b>PCM-F11</b>	3
			1 second	20 to 300 seconds	0,05	<b>PCM-G11</b>	3

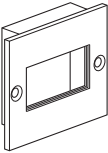

## Mounting bezels

Type	Description	Weight Kg	Order code	D
	For PCM-F11 and PCM-G11 mounting in 60 x 75 mm cut-out	0,015	<b>PXC-ZM6075</b>	3
	For PCM-F11 and PCM-G11 mounting in 72 x 72 mm cut-out	0,015	<b>PXC-ZM7272</b>	3

## Bezels for DIN rail mounting

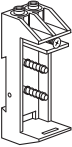
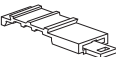
Type	Description	Weight Kg	Order code	D
	For (non-reversible) clip-on mounting of PCM-F11 and PCM-G11 on push-in connection subbase	0,020	<b>PXC-ZA35</b>	3
	35 mm DIN rail latching device for PXC-ZA35 subbases	0,010	<b>PXC-ZE35</b>	3

## Lockable cover

Degree of protection IP 55

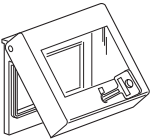
Type	Description	Weight Kg	Order code	D
	Transparent cover key lockable for 60x75 bezel for PCP-A11, PCP-S11, PCP-MA11, PCP-MB11	0,025	<b>PXC-B1</b>	3
	For PCT-B11	0,018	<b>PXC-A1</b>	3

# Logic Processing

## Dimensions, Logic processing

### Modular sequencer

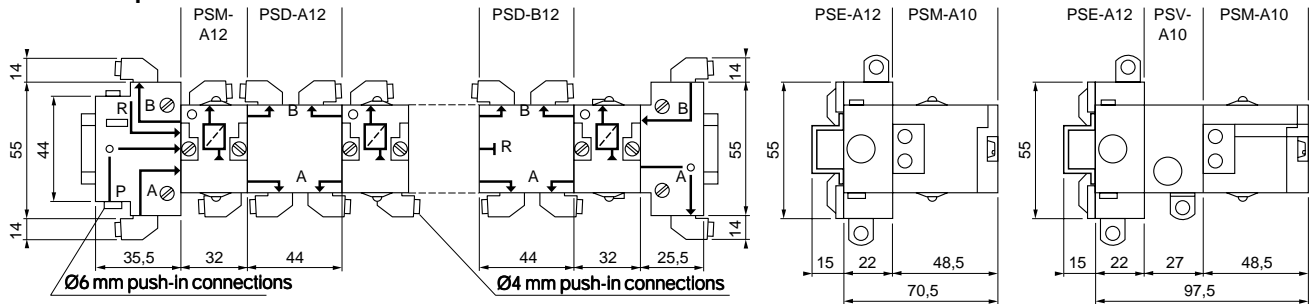

### Line mounted logic elements

PLL-A11 and PLK-A11

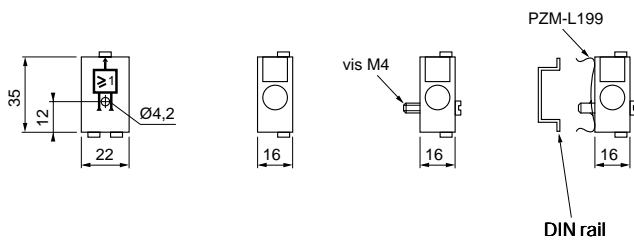

### Combinable logic elements

PLE-B12 — PLL-B12 — PLK-B12 and PLN-B12

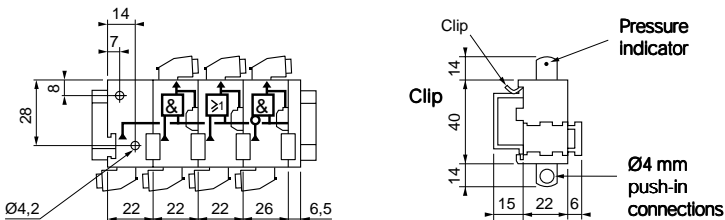

### Logic elements mounted on 3-port modular subbases

PZU-E12

PLJ-C10 — PLN-C10 — PLK-C10 and PLL-C10 mounted on PZU-C12 and PZU-A12

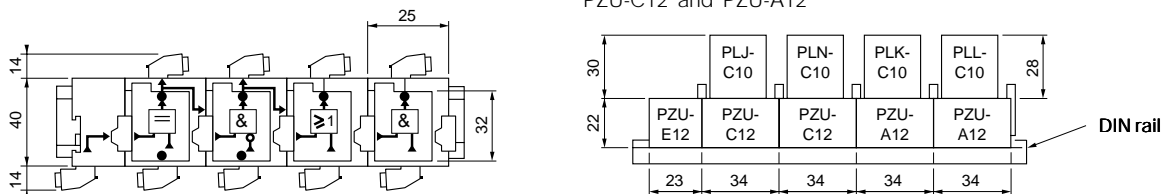

# Logic Processing

## 3 and 4-port modular subbases

PZU-E12 — PZU-C12 — PZU-A12

PZU-B12

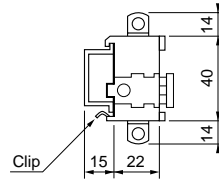
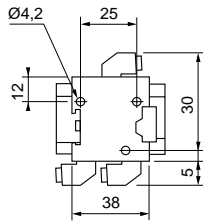
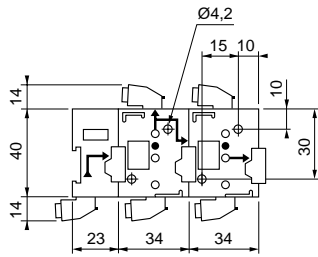

## Relays mounted on 3-port modular subbases

PRT-A12 — PRF-A12 — PRE-A12 — PRS-A121 and PLN-D12

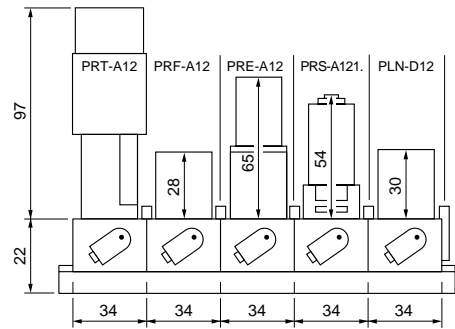
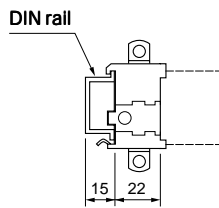
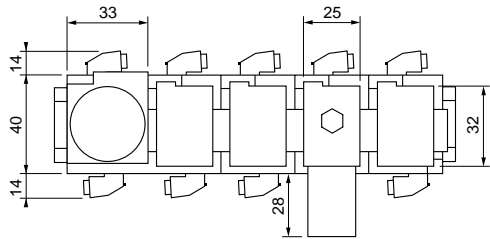

## Relays mounted on 4-port modular subbases

PLM-A12 and PRD-A12

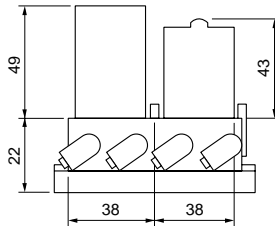
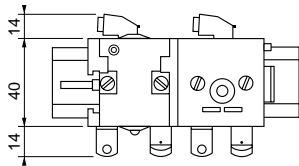

## Pressure switch

PS1-P1091

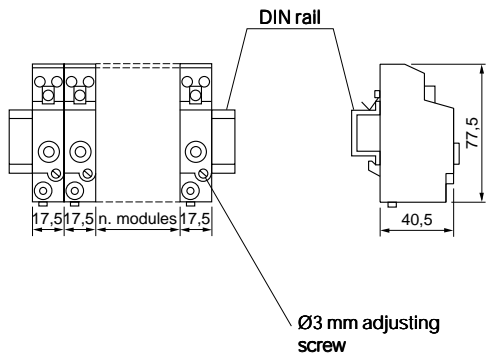

# Logic Processing

## Totalling counters

PCT-A11 PCT-B11

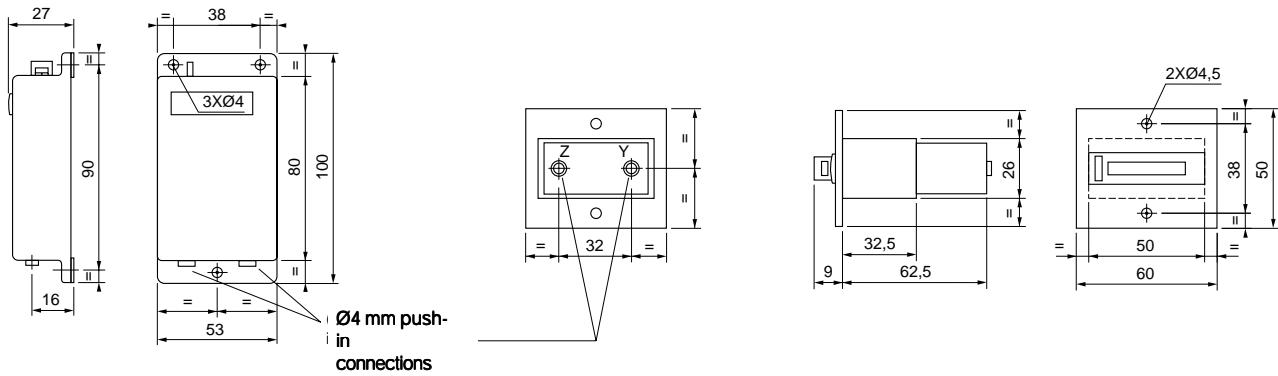

## Preselection counters

PCP-A11 and PCP-S11

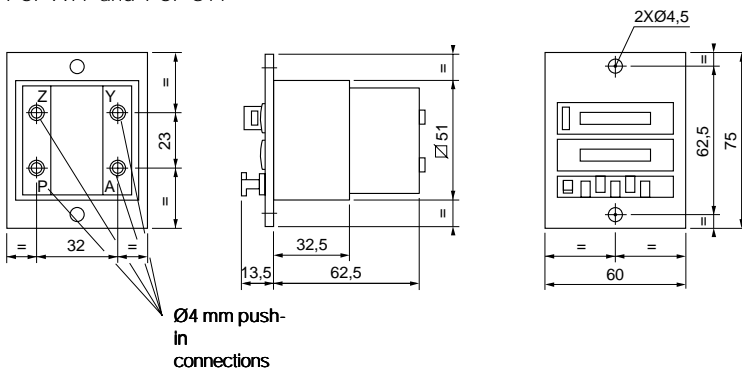

## Digital display timers

PCM-A11 and PCM-B11

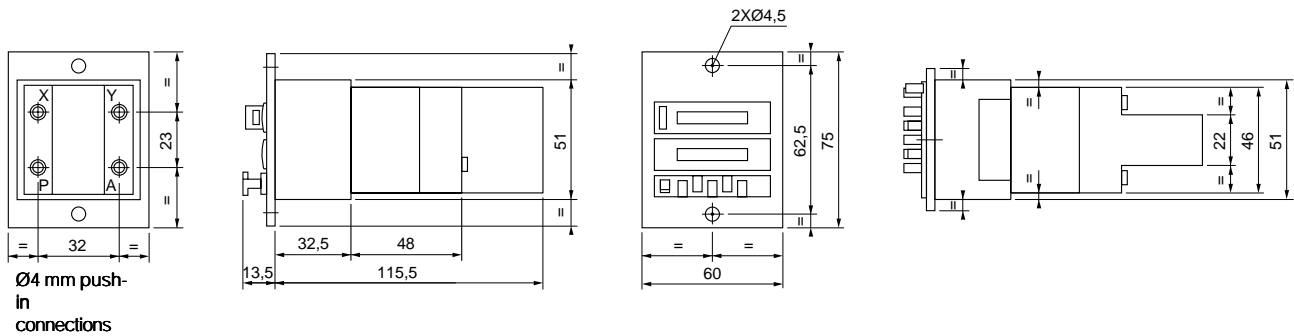

## Timers with calibrated dial

PCM-F11 and PCM-G11

