

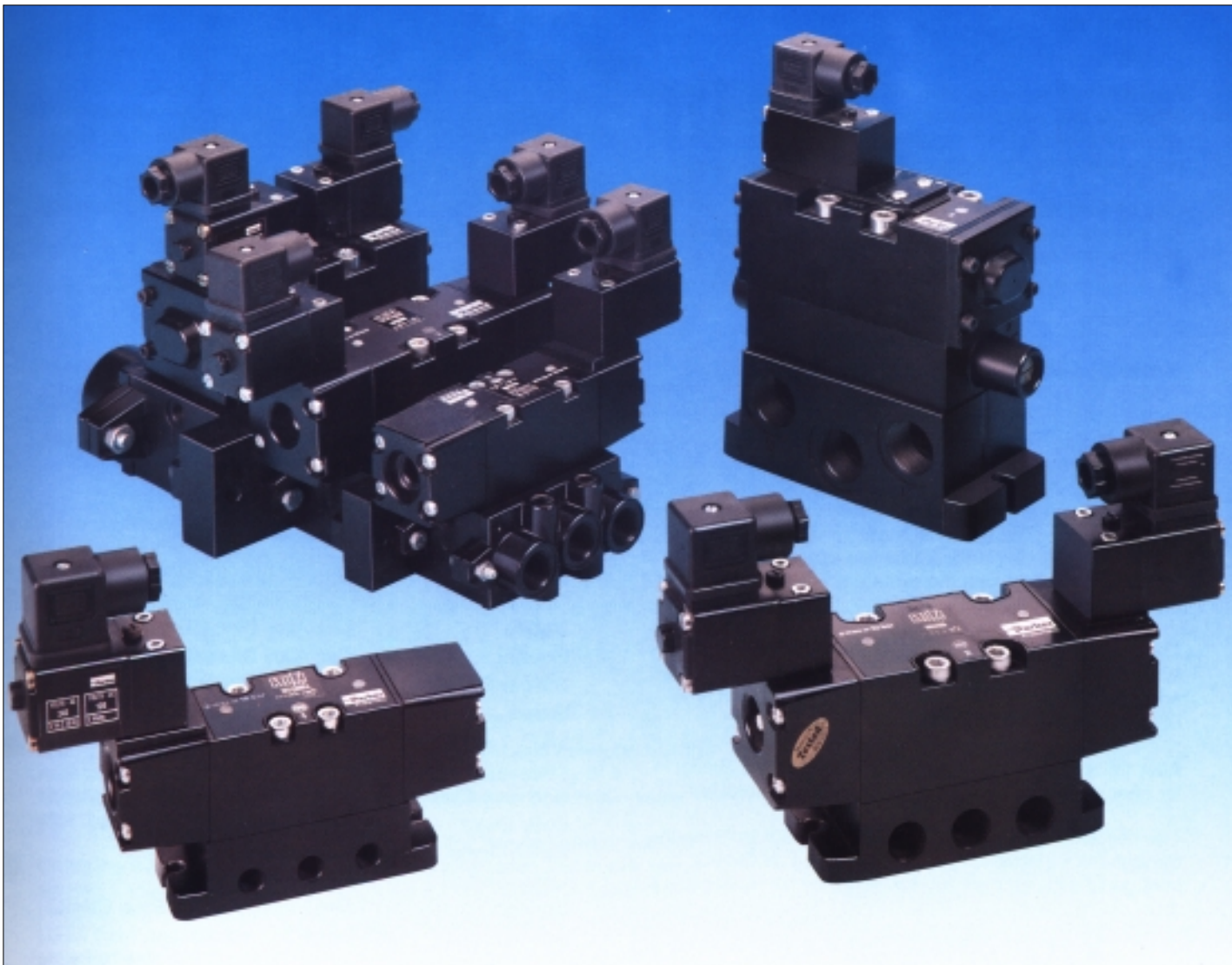

I.S.O. Valves

Apollo Series;
Sizes 1, 2 & 3

Catalogue 2120GB-ca



I.S.O. Valves

A high quality, high performance range of spool valves, designed to conform to I.S.O. standard 5599/1 in respect of the basic sub-base foot print. This range covers I.S.O. sizes 1, 2 and 3, all available in 5/2 or 5/3 configurations.

This provides International flexibility for users, by ensuring all valves conforming to one of the standard's size categories will interface with any I.S.O. base also conforming to that same size category. In addition, the valves are also compatible with the European C.N.O.M.O. standards: 060512, size 2 are compatible with sub-bases conforming to C.N.O.M.O. 060501, and size 3 conform to C.N.O.M.O. 060502

Actuators

Available with solenoid pilot, air pilot or hand lever actuators and with a choice of solenoid-pilot, air pilot, differential air pilot (air spring), spring or hand lever return mechanisms. Solenoid-pilot and differential pilot mechanisms have internal air supplies as standard, but may be field converted to external supply if required. An optional tell-tale / manual override is available on all actuator and return mechanisms.

Solenoid-Pilot Actuators

On I.S.O. size 1 and 2 two distinct types of solenoid-pilot actuators are available: the C.N.O.M.O. recommended coil configuration has the coil assembly mounted horizontally on the valve with the solenoid armature operating along the same axis as the valve spool. The alternative version features the assembly mounted in an upright position with the armature operating at 90° to the spool.

The solenoid-pilots feature a low profile epoxy encapsulated 5 watt coil, with a built-on exhaust muffler and M5 threaded port. The cable plug connection is to I.S.O. 4400 and features a collet type cable lock.

Alternative 8 watt or 2,5 watt solenoid coils are available for special applications, consult Technical Sales Dept.

The coil and plug may be reorientated in 90° increments through 360° on the upright coils, on the C.N.O.M.O. configuration versions only the plug may be reorientated.

All sizes offer a superb combination of advanced features. Special design attention has been afforded to spool and seal relationship. The lightweight aluminium spool is specially finished to give glass-like low friction wear resistant surface. The new static seals are a high fibre Nitrile composite material, so designed that they carefully caress the spool, producing the lowest friction and stiction combined with bubble-tight sealing. The spacer shell stack is metal to metal, therefore no additional compression is transmitted to the seals. All bushes and pistons are of lightweight 'Acetal Resin' which has good low friction properties.

Non-Lube Operation

All valves in the range may be used non-lube. Pre-lubricated during assembly, the combination of low friction spool and high quality seals enables them to be used with unlubricated air, but with the life expectancy of a standard pneumatic valve. The lightweight spool and seal assembly also enables the valves to be used in any plane from vertical to horizontal.

Sandwich Interface Function Plates

The Sandwich Flow Control plates allow fine adjustment of exhaust flows to provide accurate speed control of pneumatic cylinders.

Materials

Bodies	: Zinc Alloy Diecasting to BS1004A
Housings	: Zinc Alloy Diecasting to BS1004A
Spacer Shells	: Zinc Alloy Diecasting to BS1004A
Bases	
I.S.O. 1 + 2	: Zinc Alloy Diecasting to BS1004A
I.S.O. 3	: Aluminium Alloy
Bushes + Pistons	: Acetal Resins
Body Seals	: High Fibre Nitrile Composite
Piston Seals	: Nitrile
Other Seals	: Nitrile
Springs	: Zinc Plated Carbon Steel EN49C range 3

Optional

Tell tale	: Brass
-----------	---------

Features

C.N.O.M.O. specification solenoids available on I.S.O. size 1 and 2. Fitted as standard on I.S.O. size 3

Epoxy encapsulated 5 watt coils with built on exhaust muffler and M5 threaded port. The simple plug-in connection is to I.S.O. 4400 and features a collet cable lock. Both plug and coil may be re-orientated through 360° in 90° increments, on upright solenoids

Aluminium spool assembly, specially finished to provide a glass like low friction, wear resistant surface.

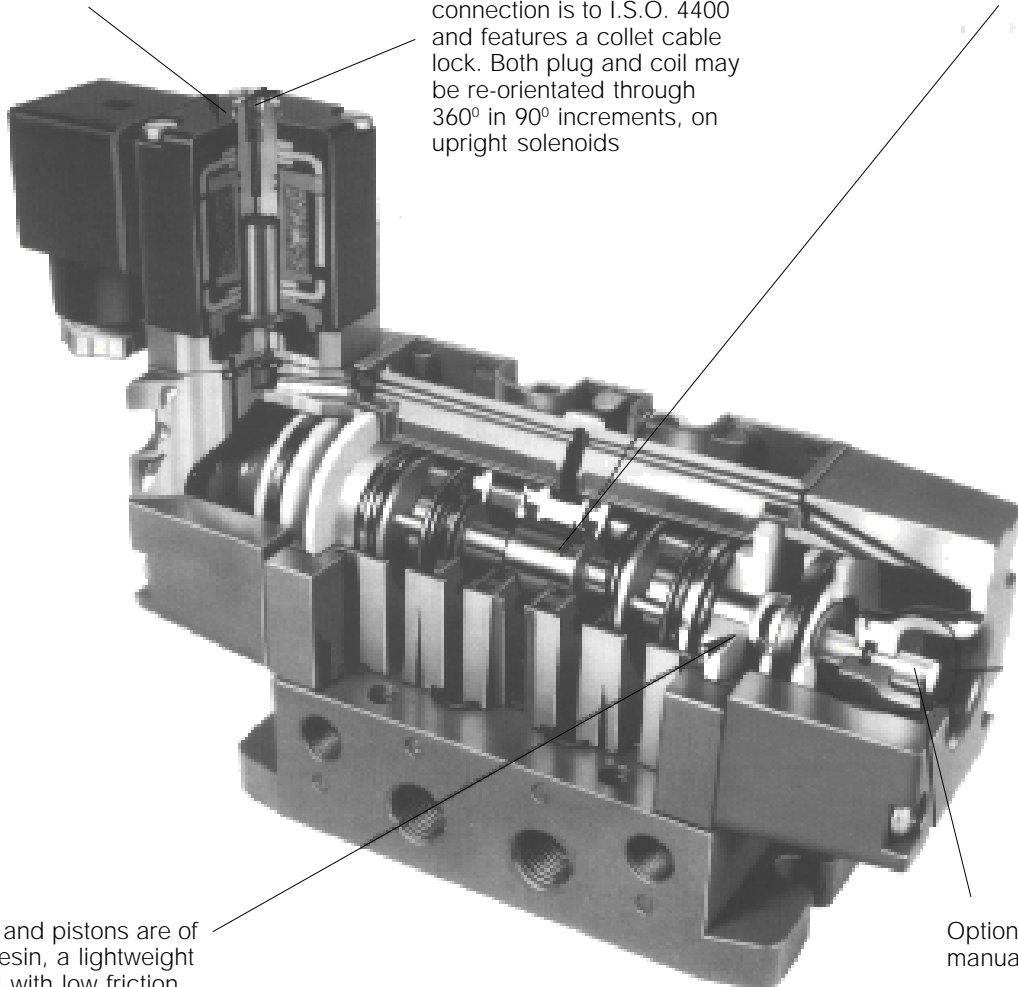

Bushes and pistons are of acetal resin, a lightweight material with low friction properties.

Optional brass tell-tale / manual override.

- Over 700 variations can be assembled from just 18 sub-assemblies in each I.S.O. size
- Complies with I.S.O. standard 5599/1 and will interface with any other I.S.O. base and can be mounted onto a C.N.O.M.O. standard base.

- When used non-lube has the life expectancy of a standard pneumatic valve.
- Will operate with or without lubrication and in any plane from vertical to horizontal.

The special features that provide non-lube, long life characteristics.

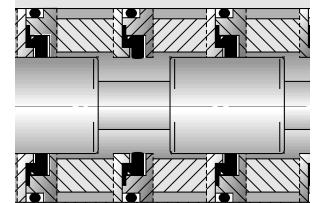

Metal to metal shell stack

Composite seal with nitrile base, so designed that it carefully caresses the spool.

I.S.O. Valves

Standardised Dimensions: Valve to Sub-bases

Mounting surface dimensions conform to I.S.O. 5599/1.
Pneumatic fluid power - Five-port directional control
valves - mounting surfaces - Part 1: General

Port connections are numbered in accordance with
C.E.T.O.P. RP68P. On a standard 5/2 spring return
valve port connection 1 is the inlet and port 1 and 2 are
connected.

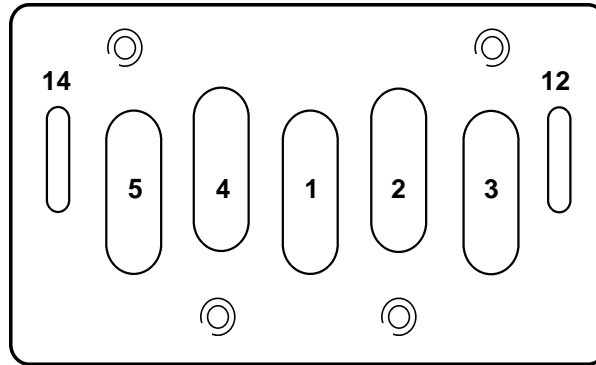

Valve body mounting hole dimensions

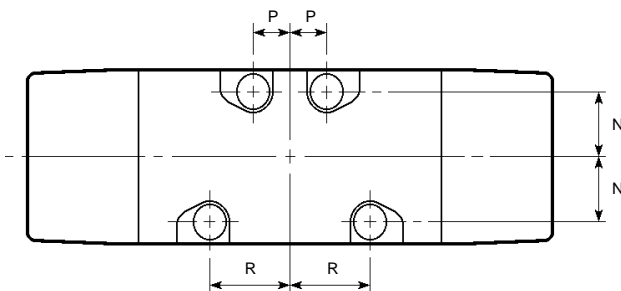

Dimensions (mm)

Standard	N	P	R	Mounting bolts
I.S.O. Size 1	14	9	18	M5
C.N.O.M.O. 060512	13	9	18	M4
I.S.O. Size 2	19	12	24	M6
C.N.O.M.O. 060501	20	17	30	M5
I.S.O. Size 3	21	24	43	M8
C.N.O.M.O. 060502	21	24	43	M5

Note:

Valve to sub-base mounting bolts are included with
each valve. These bolts should be tightened
to 50 ibf ins. (7 Nm)

Pilot valve to main valve

Mounting surface dimensions conform to C.N.O.M.O.

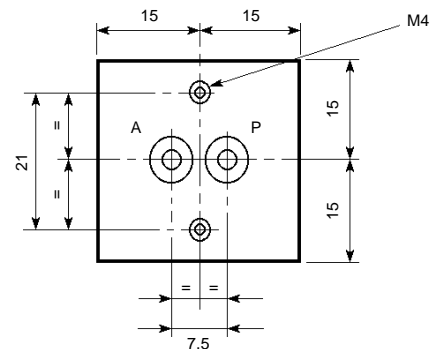

Sub base port sized

I.S.O.	Nominal Valve Size	Port sizes		(Sub bases)	
1	1/4"	G1/8	G1/4	-	-
2	3/8"	-	G1/4	G3/8	G1/2
3	1/2"	-	-	-	G1/2 G3/4

Technical Information

General

Type	Spool Valve
Mounting	Sub-base or Gang manifold
Mounting Position	Any plane
Temperature ranges	
Air pilot valves:	-10°C to 80°C
Solenoid valves:	-10°C to +55°C
Max. Inlet Pressure	p =10 bar max.

Maximum Flow to Atmosphere (dm³/s at 7 bar inlet)

Valve Function	ISO size 1		ISO size 2			ISO size 3
	G ¹ / ₈	G ¹ / ₄	G ¹ / ₄	G ³ / ₈	G ¹ / ₂	G ¹ / ₂
2 Position valves	25,4	25,9	56,6	70,8	77,4	151
3 Position valves						
Neutral	25,4	25,9	56,6	70,8	77,4	151
Negative	27,3	30,2	59,0	75,5		
Positive	25,4	25,9	56,6	70,8	77,4	151

Cv Factors

Valve Function	ISO size 1		ISO size 2			ISO size 3
	G ¹ / ₈	G ¹ / ₄	G ¹ / ₄	G ³ / ₈	G ¹ / ₂	G ¹ / ₂
5/2 position valves	.87	.92	1.70	2.00	2.30	4.80
5/3 position valves						
Neutral	.87	.92	1.70	2.00	2.30	4.80
Negative	.90	.97	1.85	2.10	2.40	
Positive	.87	.92	1.70	2.00	2.30	4.80

Minimum Air Pilot Operating Pressure (bar)

	ISO 1	ISO 2	ISO 3
Return			
Spring	2,5	1,5	3,0
Air Pilot	1,0	0,5	1,5
Self Centring	2,0	2,0	3,0

Differential Pilot

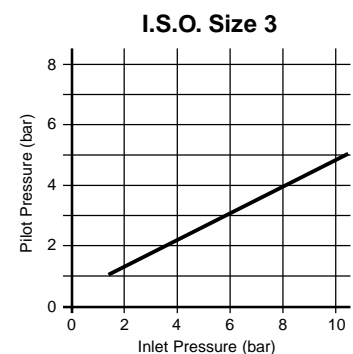
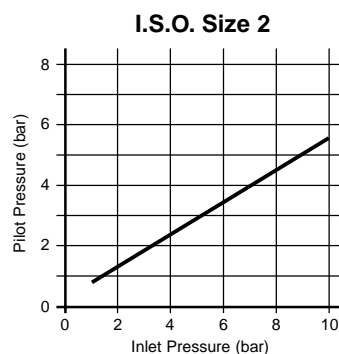
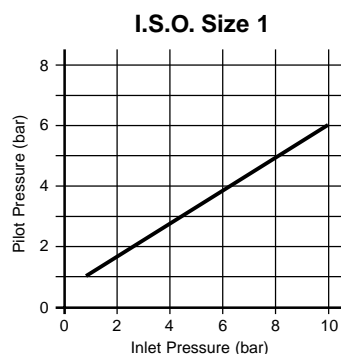

Electric Characteristics

Coil consumption	5 W = Options: 8w or 2.5w
Inrush	9 VA
Hold	6 VA
Duty Cycle	100% ED
Protection Class	IP65 (DIN40050)
Connection	Electr. Plug ISO 4400 (DIN43650 Form A)

Standard Voltage Range

Suffix	50 Hz A.C.	D.C.
T	10-13	5-6.5
TA	21-26	10-13
TF	44-55	21-26
TC	85-110	43-55
S	94-121	54-69
TS	153-198	76-99
TL	187-240	93-121
SA	204-264	102-132











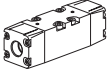

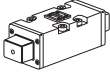
Coils are dual rated for AC and DC operation over the specified voltage range.

Other voltages and solenoid types on request.

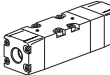
Note: Solenoid pilot valves have an internal air supply. This may be field converted to external supply if the inlet pressure is below minimum shown.









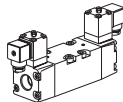

I.S.O. Valves

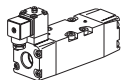
Main data for directional control valves, Apollo Series

Symbol	ISO size	Actuator	Return	Signal pressure min, bar at 6 bar actua./return	Changeover time, ms at 6 bar actua./return	Weight Kg	Order code
Pneumatically actuated 5/2 and 5/3 valves							
		1	Air	Air	1,0/1,0	6/6	0,93 19104PP
		2			0,5/0,5	15/15	1,41 29104PP
		3			1,5/1,5	15/15	1,89 39104PP
		1	Air	Differential air	3,8/-	6/35	0,94 19104PJ*
		2			3,5/-	15/150	1,44 29104PJ*
		3			2,5/-	15/150	2,18 39104PJ*
		1	Air	Spring	2,5/-	6/35	0,94 19104PS
		2			1,5/-	15/15	1,38 29104PS
		3			3,0/-	15/150	1,75 39104PS
		1	Air	Air	2,0/2,0	6/35	1,06 19104PX
		2	Closed centre position	self centring	2,0/2,0	15/150	1,66 29104PX
		3			3,0/3,0	15/150	2,22 39104PX
		1	Air	Air	2,0/2,0	6/35	1,06 19104PY
		2	Vented centre position	self centring	2,0/2,0	15/150	1,66 29104PY
		3			3,0/3,0	15/150	2,22 39104PY
		1	Air	Air	2,0/2,0	6/35	1,06 19104PZ
		2	Pressurised centre position	self centring	2,0/2,0	15/150	1,66 29104PZ
		3			3,0/3,0	15/150	2,22 39104PZ

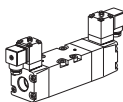
* This valve can be used as priority air pilot actuated valve

Main data for directional control valves, Apollo Series

Symbol	ISO size	Actuator	Return	Signal pressure min. bar at 6 bar actua./return	Changeover time, ms at 6 bar actua./return	Weight Kg	Order code	
Electrically actuated 5/2 and 5/3 valves								
With manual override								
Upright solenoid pilot								
		1	Electric	Electric	1,0/1,0	20/20	1,42	19124M*
		2			0,5/0,5	25/25	1,85	29124M*
		1	Electric	Spring	2,5/-	25/75	1,18	19114M*
		2			1,5/-	30/180	1,60	29114M*
	1	Electric	Differential air	3,8/-	25/75	1,18	19134MJ*	
	2			3,5/-	30/180	1,66	29134MJ*	
	1	Electric	Air	1,0/1,0	20/6	1,18	19134M*	
	2			0,5/0,5	25/15	1,63	29134M*	
		1	Electric	Electric	2,0/2,0	25/75	1,56	19124MX*
		2	Closed centre position	self centring	2,0/2,0	30/180	2,13	29124MX*
	1	Electric	Electric	2,0/2,0	25/75	1,56	19124MY*	
	2	Vented centre position	self centring	2,0/2,0	30/180	2,13	29124MY*	
	1	Electric	Electric	2,0/2,0	25/75	1,56	19124MZ*	
	2	Pressurised centre position	self centring	2,0/2,0	30/180	2,13	29124MZ*	

* Specify voltage and add suffix letters

*Suffix	50 Hz AC	DC
T	10-13	5-6,5
TA	21-26	10-13
TF	44-55	21-26
TC	85-110	43-55
S	94-121	54-69
TL	187-240	93-121
SA	204-264	102-132











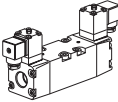

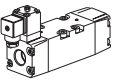
Coils are dual rated for AC and DC operation over the specified voltage range.

Note:

Solenoid pilot valves have an internal air supply. This may be field converted to external supply if the inlet pressure is below minimum shown

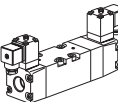
I.S.O. Valves

Main data for directional control valves, Apollo Series

Symbol	ISO size	Actuator	Return	Signal pressure min, bar at 6 bar actua./return	Changeover time, ms at 6 bar actua./return	Weight Kg	Order code
Electrically actuated 5/2 and 5/3 valves							
Without manual override							
Upright solenoid pilot							
		1	Electric	Electric	1,0/1,0	20/20	1,42 19124*
		2			0,5/0,5	25/25	1,85 29124*
		1	Electric	Spring	2,5/-	25/75	1,18 19114*
		2			1,5/-	30/180	1,60 29114*
		1	Electric	Differential	3,8/-	25/75	1,18 19134J*
		2		air	3,5/-	30/180	1,66 29134J*
		1	Electric	Air	1,0/1,0	20/6	1,18 19134*
		2			0,5/0,5	25/15	1,63 29134*
		1	Electric	Electric	2,0/2,0	25/75	1,56 19124X*
		2	Closed centre position	self centring	2,0/2,0	30/180	2,13 29124X*
		1	Electric	Electric	2,0/2,0	25/75	1,56 19124Y*
		2	Vented centre position	self centring	2,0/2,0	30/180	2,13 29124Y*
		1	Electric	Electric	2,0/2,0	25/75	1,56 19124Z*
		2	Pressurised centre position	self centring	2,0/2,0	30/180	2,13 29124Z*

* Specify voltage and add suffix letters











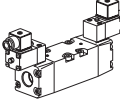

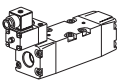

*Suffix	50 Hz AC	DC
T	10-13	5-6,5
TA	21-26	10-13
TF	44-55	21-26
TC	85-110	43-55
S	94-121	54-69
TL	187-240	93-121
SA	204-264	102-132

Coils are dual rated for AC and DC operation over the specified voltage range.

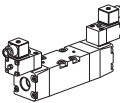
Note:

Solenoid pilot valves have an internal air supply. This may be field converted to external supply if the inlet pressure is below minimum shown

Main data for directional control valves, Apollo Series

Symbol	ISO size	Actuator	Return	Signal pressure min, bar at 6 bar actua./return	Changeover time, ms at 6 bar actua./return	Weight Kg	Order code	
Electrically actuated 5/2 and 5/3 valves								
CNOMO solenoid pilot								
With manual override								
		1	Electric	Electric	1,0/1,0	20/20	1,60	19424M*
		2			0,5/0,5	25/25	2,02	29424M*
		3			1,50/1,50	25/25	2,50	39424M*
		1	Electric	Spring	2,5/-	25/75	1,27	19414M*
		2			1,5/-	30/180	1,68	29414M*
		3			3,0/-	30/180	2,06	39414M*
		1	Electric	Differential air	3,8/-	25/75	1,27	19434MJ*
		2			3,5/-	30/1/80	1,74	29434MJ*
		3			2,5/-	25/75	2,47	39434MJ*
		1	Electric	Air	1,0/1,0	20/6	1,26	19434M*
		2			0,5/0,5	25/15	1,72	29434M*
		3			1,5/1,5	25/15	2,20	39434M*
		1	Electric	Electric	2,0/2,0	25/75	1,73	19424MX*
		2	Closed centre	self	2,0/2,0	30/180	2,29	29424MX*
		3	position	centring	3,0/3,0	25/75	2,81	39424MX*
		1	Electric	Electric	2,0/2,0	25/75	1,73	19424MY*
		2	Vented	self	2,0/2,0	30/180	2,29	29424MY*
		3	centre position	centring	3,0/3,0	25/75	2,81	39424MY*
		1	Electric	Electric	2,0/2,0	25/75	1,73	19424MZ*
		2	Pressurised	self	2,0/2,0	30/180	2,29	29424MZ*
		3	centre position	centring	3,0/3,0	25/75	2,81	39424MZ*

* Specify voltage and add suffix letters

For valve with optional non-locking override on solenoid, replace suffix "M" with "N"

*Suffix	50 Hz AC	DC
T	10-13	5-6,5
TA	21-26	10-13
TF	44-55	21-26
TC	85-110	43-55
S	94-121	54-69
TL	187-240	93-121
SA	204-264	102-132











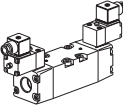

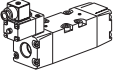

Coils are dual rated for AC and DC operation over the specified voltage range.

Note:

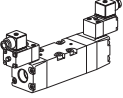
Solenoid pilot valves have an internal air supply. This may be field converted to external supply if the inlet pressure is below minimum shown

I.S.O. Valves

Main data for directional control valves, Apollo Series

Symbol	ISO size	Actuator	Return	Signal pressure min, bar at 6 bar actua./return	Changeover time, ms at 6 bar actua./return	Weight Kg	Order code	
Electrically actuated 5/2 and 5/3 valves								
CNOMO solenoid pilot								
Without manual override								
		1	Electric	Electric	1,0/1,0	20/20	1,60	19424*
		2			0,5/0,5	25/25	2,02	29424*
		3			1,5/1,5	25/25	2,50	39424*
		1	Electric	Spring	2,5/-	25/75	1,27	19414*
		2			1,5/-	30/180	1,68	29414*
		3			3,0/-	30/180	2,06	39414*
		1	Electric	Differential air	3,8/-	25/75	1,27	19434J*
		2			3,5/-	30/180	1,74	29434J*
		3			2,5/-	30/180	2,47	39434J*
		1	Electric	Air	1,0/1,0	20/6	1,26	19434*
		2			50/50	25/115	1,72	29434*
		3			1,5/1,5	25/115	2,20	39434*
		1	Electric	Electric	2,0/2,0	25/75	1,73	19424X*
		2	Closed centre position	self centring	2,0/2,0	30/180	2,29	29424X*
		3			3,0/3,0	25/75	2,81	39424X*
		1	Electric	Electric	2,0/2,0	25/75	1,73	19424Y*
		2	Vented centre position	self centring	2,0/2,0	30/180	2,29	29424Y*
		3			3,0/3,0	25/75	2,81	39424Y*
		1	Electric	Electric	2,0/2,0	25/75	1,73	19424Z*
		2	Pressurised centre position	self centring	2,0/2,0	30/180	2,29	29424Z*
		3			3,0/3,0	25/75	2,81	39424Z*

* Specify voltage and add suffix letters

*Suffix	50 Hz AC	DC
T	10-13	5-6,5
TA	21-26	10-13
TF	44-55	21-26
TC	85-110	43-55
S	94-121	54-69
TL	187-240	93-121
SA	204-264	102-132

Coils are dual rated for AC and DC operation over the specified voltage range.

Note:

Solenoid pilot valves have an internal air supply. This may be field converted to external supply if the inlet pressure is below minimum shown

Dimensions, Apollo valve series

All dimensions in mm unless otherwise stated

5/2 - Single solenoid actuated valves

Upright solenoid ISO 1 and 2

Type	ISO size	A	B	C*	D	E	F	G	H	J	K
19114, 19134	1	168	40	93	29	40	72	32,5	68	32	40
29114, 29134	2	187	50	99	32	50	90	32,5	77	32	50

* For 2,5 and 8 watt solenoids increase by 16 mm

CNOMO solenoid Type ISO 1 and 2

Type	ISO size	A*	B	C	D	E	F	G	H	J	K
199414, 19434	1	186	40	107	29	40	72	32,5	68	50	40
299414, 29434	2	204	50	112	32	50	90	32,5	77	50	50

* For 2,5 and 8 watt solenoids increase by 16 mm

CNOMO solenoid Type ISO 3

Type	ISO size	A	B	C	D	E	F	G	H	J	K
39414, 39434	3	175	63,5	118	31	58	115,5	148	57,5	30	71

I.S.O. Valves

5/2 - Double solenoid actuated valves

Upright solenoid ISO 1 and 2

Type	ISO size	A	B	C*	D	E	F	G	H	J	K
19124	1	200	40	93	29	40	72	32,5	68	32	40
29124	2	218	50	99	32	50	90	32,5	77	32	50

* For 2,5 and 8 watt solenoids increase by 16 mm

CNOMO solenoid Type ISO 1 and 2

Type	ISO size	A*	B	C	D	E	F	G	H	J	K
19424	1	236	40	107	29	40	72	32,5	68	50	40
29424	2	254	50	112	32	50	90	32,5	77	50	50

* For 2,5 and 8 watt solenoids increase by 16 mm

CNOMO solenoid Type ISO 3

Type	ISO size	A	B	C	D	E	F	G	H	J	K
39424	3	175	63,5	118	31	54	115,5	148	57,5	30	71

5/3 - Double solenoid actuated valves

Upright solenoid ISO 1 and 2

Type	ISO size	A	B	C*	D	E	F	G	H	J	K
19124X/Y/Z	1 228	40	93	29	40	72	60	68	32	40	
29124X/Y/Z	2 252	50	99	32	50	90	66	77	32	50	

* For 2,5 and 8 watt solenoids increase by 16 mm

CNOMO solenoid Type ISO 1 and 2

Type	ISO size	A*	B	C	D	E	F	G	H	J	K
19424X/Y/Z	1 264	40	107	29	40	72	60	68	50	40	
29424X/Y/Z	2 288	50	112	32	50	90	66	77	50	50	

* For 2,5 and 8 watt solenoids increase by 16 mm

CNOMO solenoid Type ISO 3

Type	ISO size	A	B	C	D	E	F	G	H	J	K
39424X/Y/Z	3 215	63,5	118	31	54	115,5	148	57,5	30	71	

I.S.O. Valves

5/3 - Solenoid actuated - Pilot return valves

Upright solenoid ISO 1 and 2

Type	ISO size	A	B	C*	D	E	F	G	H	J	K
19134X Y/Z	1	196	40	93	29	40	72	60	68	32	40
29134X Y/Z	2	220	50	99	32	50	90	66	77	32	50

* For 2,5 and 8 watt solenoids increase by 16 mm

CNOMO solenoid Type ISO 1 and 2

Type	ISO size	A*	B	C	D	E	F	G	H	J	K
19434X Y/Z	1	214	40	107	29	40	72	60	68	50	40
29434X Y/Z	2	238	50	112	32	50	90	66	77	50	50

* For 2,5 and 8 watt solenoids increase by 16 mm

CNOMO solenoid Type ISO 3

Type	ISO size	A	B	C	D	E	F	G	H	J	K
39434X Y/Z	3	215	63,5	118	31	58	115,5	148	57,5	30	71

5/2 - Air pilot operated valves

ISO 1 and 2

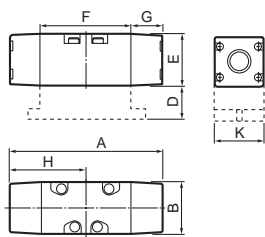

Type	ISO size	A	B	C	D	E	F	G	H
19104P	1	137	40	40	29	40	72	32,5	68
29104P	2	155	50	50	32	50	90	32,5	77

Air pilot operated, ISO 3

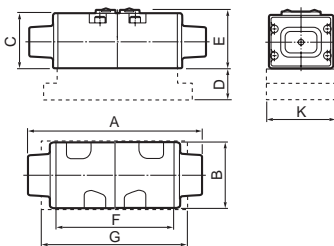

Type	ISO size	A	B	C	D	E	F	G	H
39104P	3	175	63,5	58	31	71	15,5	148	54

5/3 - Air pilot operated

Air pilot operated, ISO 1, 2 and 3

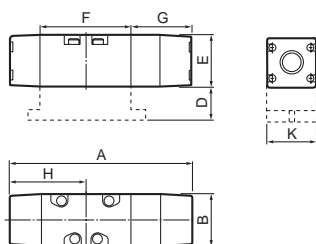

Type	ISO size	A	B	C	D	E	F	G	H
19104PXY/Z	1	164	40,0	40	29	40	72	60	68,0
29104PXY/Z	2	188	50,0	50	32	50	90	66	77,0
39104PXY/Z	3	215	63,5	58	31	71	90	92	87,5

I.S.O. Valves

Hand lever operated I.S.O. Sizes 1 & 2

5/2 - I.S.O. 1 & 2

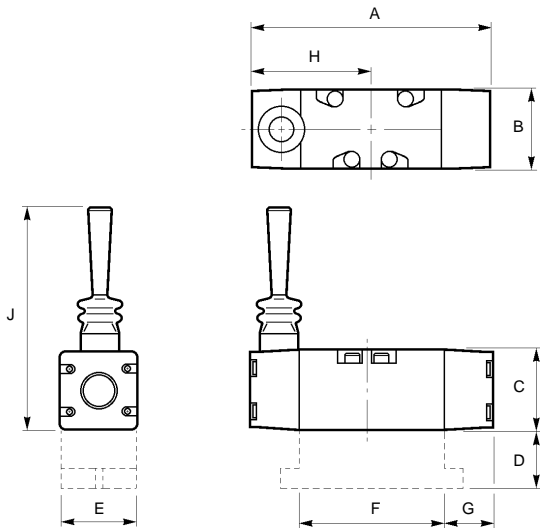

ISO Size	A	B	C	D	E	F	G	H	J
1	137	40	40	29	40	72	32,5	68	146
2	155	50	50	32	50	90	32,5	77	158

5/3 - I.S.O. 1 & 2

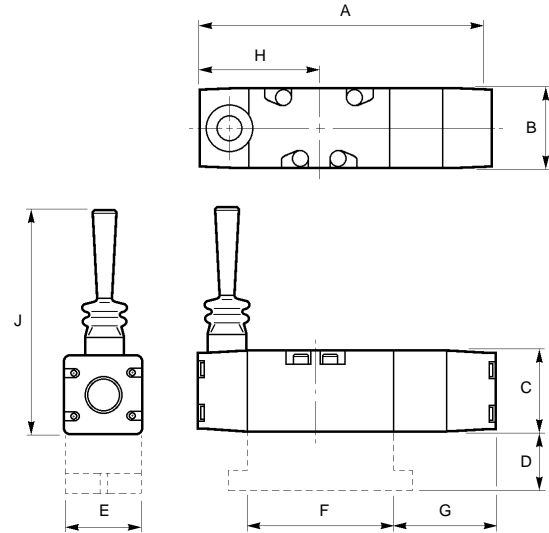

ISO Size	A	B	C	D	E	F	G	H	J
1	164	40	40	29	40	72	60	68	146
2	188	50	50	32	50	90	66	77	158

Sub-bases Side ported

Part no.	Ports	ISO Size	Weight (kg)
19701	G ^{1/8}	1	0,31
19702	G ^{1/4}		0,29
29701	G ^{1/4}	2	0,53
29702	G ^{3/8}		0,43
29703	G ^{1/2}	3	0,50
39704	G ^{1/2}		0,32
39703	G ^{3/4}		0,60

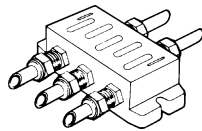

Additional dimensions for various sub-bases see page 20, 24

Bottom ported

Part no.	Ports	ISO Size	Weight (kg)
19801	G ^{1/8}	1	0,35
19802	G ^{1/4}		0,29
29801	G ^{1/4}	2	0,64
29802	G ^{3/8}		0,57

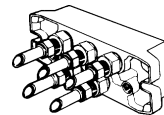

Gang Manifolds

I.S.O. 1 and 2	- Side Ported	- See page 21
I.S.O. 1 and 2	- Bottom Ported	- See page 22, 25
I.S.O. 3	- Bottom Ported	- See page 23, 26

Valve Part nos., Weights (kg)

5/2 - Hand lever operated I.S.O. Sizes 1 & 2

Part no.	ISO Size	Symbol	Return mechanism	Weight (kg)
19104LS	1		Spring	1,14
29104LS	2			2,10
19104LP	1		Air pilot	1,41
29104LP	2			2,13
19104LT	1		Lever	1,41
29104LT	2			2,10

5/3 - Hand lever operated, stay-put detent I.S.O. Size 1 & 2

Part no.	ISO Size	Symbol	Mid position	Weight (kg)
19104L	1		Neutral	1,14
29104L	2			2,10
19104LW	1		Negative	1,41
29104LW	2			2,10
19104LN	1		Positive	1,41
29104LN	2			2,10

5/3 - Hand lever operated, self centring I.S.O. Size 1 & 2

Part no.	ISO Size	Symbol	Mid position	Weight (kg)
19104LX	1		Neutral	1,54
29104LX	2			2,35
19104LY	1		Negative	1,54
29104LY	2			2,35
19104LZ	1		Positive	1,54
29104LZ	2			2,35

I.S.O. Valves

Sandwich flow control interface function plates I.S.O. Size 1, 2 & 3

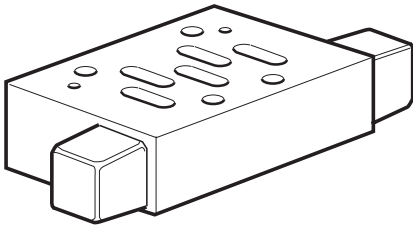

- Fine control of exhaust flow.
- Accurate cylinder speed control
- Can be assembled onto in-situ valve without disturbing pipe work.
- Simple hexagonal key adjustment.

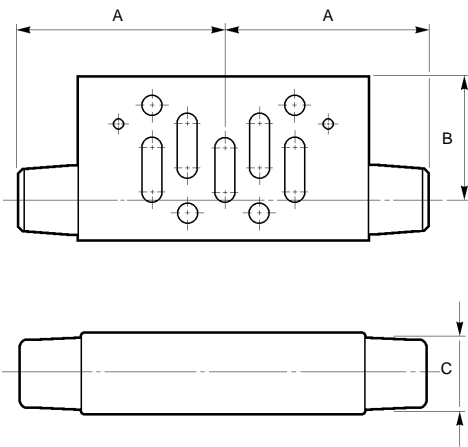

I.S.O. 1 and 2

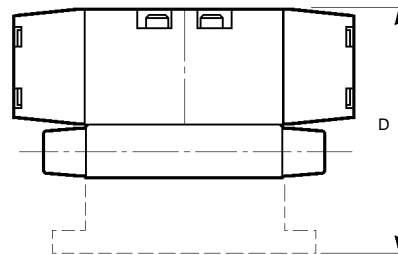

I.S.O. 3

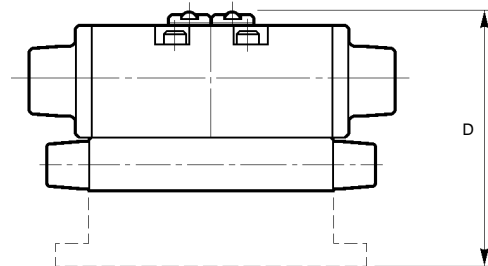

Dimensions (mm)

Part no.	Size	A	B	C	D	Weight (g)
19501	I.S.O. 1	51	30	20	89	220
29501	I.S.O. 2	67	25	26	108	348
39501	I.S.O. 3	89	33,5	33	122	860

Note: Each unit is supplied complete with a sealing gasket and longer valve to base mounting screws.

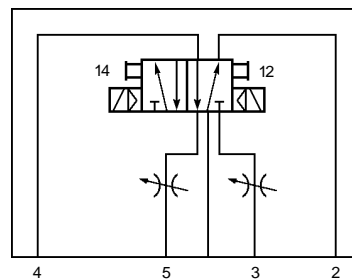

ISO valve

Flow control function

Manifold

Sandwich flow control interface function plates I.S.O. Size 1, 2 & 3

Typical ISO valve performance with sandwich flow control

Number turns from fully closed	19501(see note 1) G ^{1/4} " base			29501 (see note 2) G ^{3/8} " base			39501 (see note 3) G ^{1/2} " base		
	Time of stroke cylinder		Flow to atmosphere	Time to stroke cylinder		Flow to atmosphere	Time to stroke cylinder		Flow to atmosphere
	Outstroke (secs)	Instroke (secs)	dm ³ /s	Outstroke (secs)	Instroke (secs)	dm ³ /s	Outstroke (secs)	Instroke (secs)	dm ³ /s
1/2	3.8	4.5	0.7	3.9	4.0	2.6	3.8	5.0	3.4
1	1.9	2.0	2.2	2.0	2.2	5.5	2.0	2.4	9.2
1 1/2	1.2	1.3	4.1	1.4	1.5	8.0	1.4	1.6	14.4
2	0.85	0.95	5.6	1.1	1.2	10.1	1.1	1.3	19.2
2 1/2	0.75	0.80	7.8	0.9	1.0	12.2	1.0	1.1	24.2
3	0.48	0.52	12.8	0.8	0.9	14.1	0.9	0.95	28.9
3 1/2	0.39	0.42	15.9	0.8	0.9	15.9	0.8	0.85	36.0
4	0.36	0.38	17.5	0.7	0.85	17.7	0.75	0.8	40.2
4 1/2	0.34	0.38	18.4	0.65	0.80	19.8	0.7	0.65	50.4
5	0.34	0.38	18.6	0.64	0.75	24.5	0.65	0.62	63.9
5 1/2	0.33	0.37	18.8	0.58	0.65	51.7	0.6	0.6	74.7
6	0.33	0.37	18.9	0.57	0.60	36.8	0.6	0.6	80.8
6 1/2	0.33	0.37	19.0	0.57	0.60	39.0	0.58	0.6	86.2
7	0.32	0.36	19.0	0.57	0.60	40.1	0.56	0.6	88.1
7 1/2	0.32	0.36	19.0	0.56	0.60	40.8	0.56	0.6	88.1

1) Operating a 50mm bore x 250mm stroke ISO cylinder

2) Operating a 80mm bore x 250mm stroke ISO cylinder

3) Operating a 100mm bore x 250mm stroke ISO cylinder

I.S.O. Valves

Single sub-base: I.S.O. 1, 2 & 3

Side ported

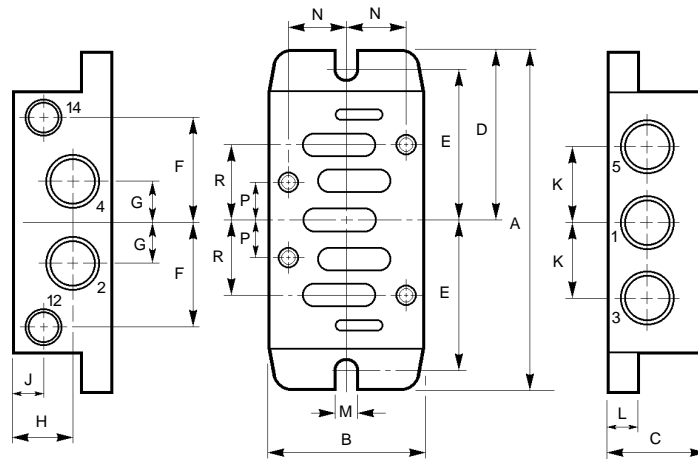

Part nos., dimensions (mm)

Part no.	I.S.O. Size	Port Size	A	B	C	D	E	F	G	H	J	K	L	M	N	P	R
19701	1	G ^{1/8}	100	40	29	50	45	30,5	11	18	10	22	10	5,4	14	9	18,0
19702	1	G ^{1/4}	100	40	29	50	45	30,5	11	18	10	22	10	5,4	14	9	18,0
29701	2	G ^{1/4}	116	50	32	58	52	34,0	13	19	10	26	10	6,4	19	12	24,0
29702	2	G ^{3/8}	116	50	32	58	52	34,0	13	19	10	26	10	6,4	19	12	24,0
29703	2	G ^{1/2}	124	51	42	62	56	37,0	18	24	10	34	10	6,4	19	12	24,0
39704	3	G ^{1/2}	149	71	32	74,5	68	45,0	16	15	10	34	18	6,6	24	16	32,0
39703	3	G ^{3/4}	149	71	60	74,5	68	45,0	21	33	10	40	18	6,6	24	16	32,0

Bottom ported

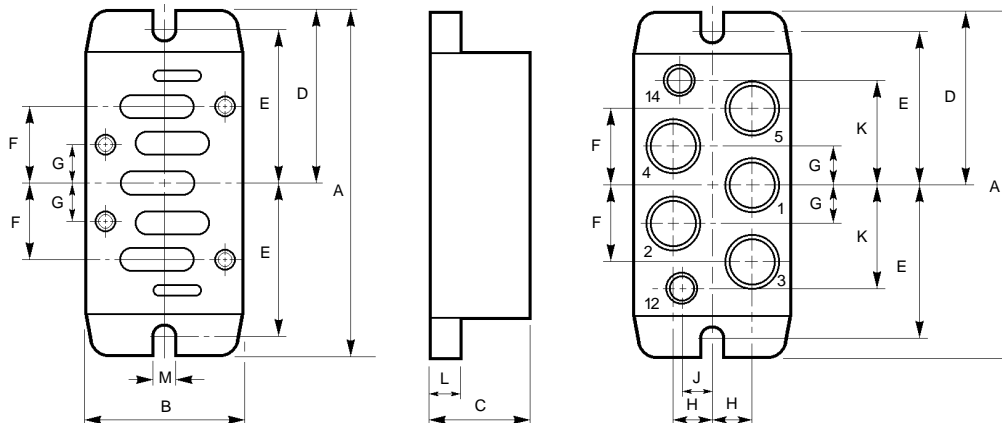

Part nos., dimensions (mm)

Part no.	I.S.O. Size	Port Size	A	B	C	D	E	F	G	H	J	K	L	M
19801	1	G ^{1/8}	100	40	29	50	45	30,5	11	9,5	9,5	22	10	5,4
19802	1	G ^{1/4}	100	40	29	50	45	30,5	11	9,5	9,5	22	10	5,4
29801	2	G ^{1/4}	116	50	32	58	52	34,0	13	12,5	10,0	26	10	6,4
29802	2	G ^{3/8}	116	50	32	58	52	34,0	13	12,5	10,0	26	10	6,4

I.S.O. Size 1 & 2. side ported manifolds

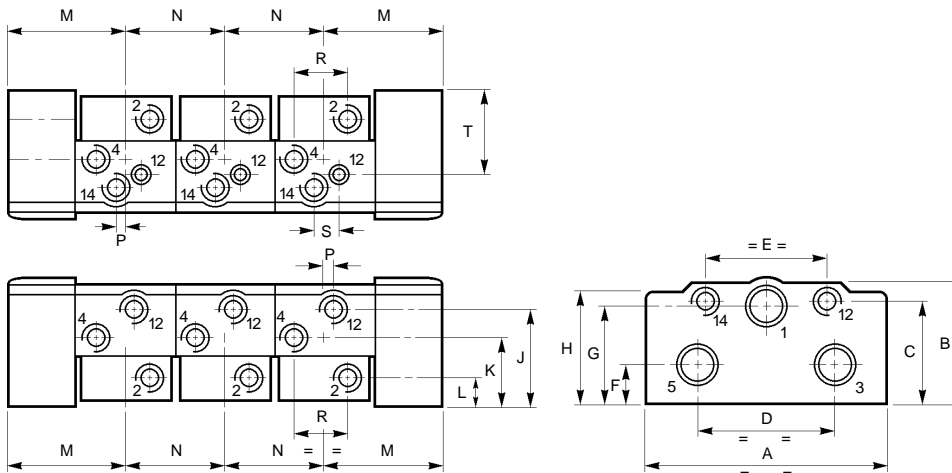

Mounting hole dimensions

I.S.O. 1

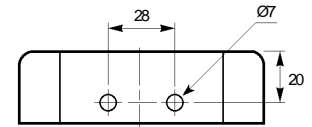

I.S.O. 2

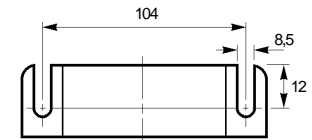

Dimensions (mm)

I.S.O. Size	Ports 1, 3, 5	Ports 2, 4	Pilot Ports 12, 14	A	B	C	D	E	F	G	H	J	K	L	M	N	P	R	S	T
I.S.O. 1	G ³ / ₈	G ¹ / ₄	G ¹ / ₈	106	53	44	59	53	16	42	48	44	13	13	52	43	4	22	8	30
I.S.O. 2	G ³ / ₄	G ¹ / ₂	G ¹ / ₈	126	80	72	62	62	30	62	72	68	36	17	68	56	10	26	20	64

The side ported manifold sub-bases are supplied in kit form complete with a set of blanking plugs. One base is required per valve. Both cylinder and pilot ports are located in each end face of the base, the unwanted ports may be blanked off with the plugs supplied. Additional bases may be connected together, and are locked in position by two integral grub screws.

The end plate kit contains the two end plates both of which incorporate inlet and exhaust ports, and two pilot ports which may be used to pilot all the manifold valves.

simultaneously. A set of blanking plugs is supplied with I.S.O. 2 end plate kits to blank off the unwanted ports: on I.S.O. 1 kits a blanking plate is provided to place between the end plate and the first manifold base at whichever end requires blanking.

An additional facility on side ported bases are selector plates which may be assembled between bases to select which ports are required to be manifold connected.

Selector plate: Function

Blank Plate : On I.S.O. 1 manifolds this plate may be assembled between the end plate kit and first base to blank off one end or, to blank off inlet and exhaust between subsequent bases.
On I.S.O. 2 manifolds blanking plugs are provided to blank off the unwanted end, the blank plate may be assembled between bases only.
It may also be used anywhere in the complete manifold assembly, should it be necessary to supply or exhaust from both ends.

1, 3, 5 Open : This plate is supplied as standard with all manifold bases. Inlet and both exhaust ports open. Both pilot ports blanked.

Part nos.

	I.S.O. 1	I.S.O. 2
Manifold kit	19902	29902
End plate kit	19906	29906
Blank plate	19911	29911
Selector plate 1, 3, 5 open	19912	29912
Selector plate 1, 3, 5, 12 or 14 open	19913	29913
Selector plate 1, 3, 5, 12 & 14 open	19914	29914

1, 3, 5, 12 or 14 : In addition to the inlet and exhaust ports one pilot port is open. Either port 12 or 14 may be utilised by reversing the plate.

1, 3, 5, 12 and 14 : All ports open including both pilot ports 12 and 14.

I.S.O. Valves

I.S.O. Size 1 & 2. Bottom ported manifolds

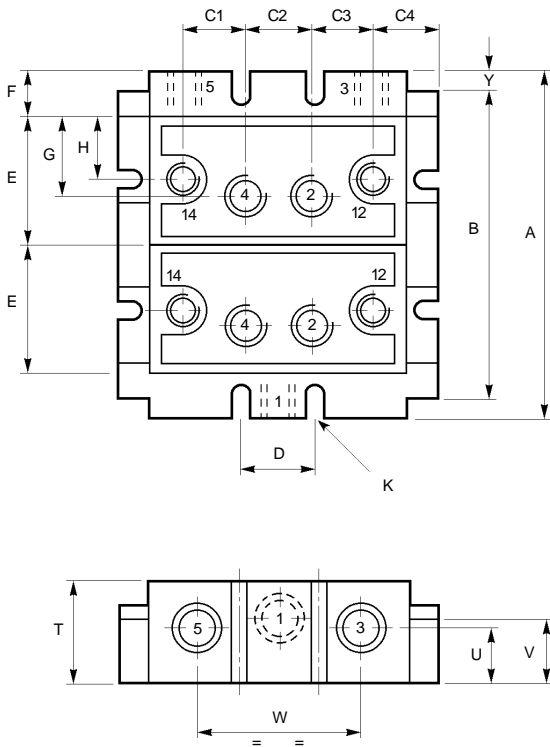

Part nos.

I.S.O. size	Manifold kit	End plate kit
I.S.O. 1	19901	19905
I.S.O. 2	29901	29905

The bottom ported manifold sub-bases are supplied in kit form with all the necessary seals and screws. One base is required per valve. The system is completely modular, further bases may be added by utilising the integral locking screws on each side of the base. The end plate kit containing the inlet and exhaust plates must be ordered separately. The inlet port is on one side and the exhaust ports are on the other.

Dimensions (mm)

I.S.O. Size	Ports 1, 3, 5	Ports 2, 4	Pilot Ports 12, 14	C1	C2	C3	C4	D	E	F	G	H	ØK	T	U	V	W	Y
I.S.O. 1	G ³ / ₈	G ¹ / ₄	G ¹ / ₈	23	24	23	23	28	43	20	20,5	17,5	6,5	35	19	22	56	10
I.S.O. 2	G ¹ / ₂	G ³ / ₈	G ³ / ₈	28	32	28	26	35	56	24	33,0	28,0	8,3	45	24	25	72	12

No. of sub-bases	I.S.O. 1		I.S.O. 2	
	A	B	A	B
3	169	149	216	192
4	212	192	272	248
5	255	235	328	304
6	298	278	384	360
7	341	321	440	416
8	384	364	496	472

I.S.O. Size 3 Manifolds G¹/₂ Cylinder port type

Part no.

Manifold kit	End plate kit	Ports 1, 3, 5	Ports 2, 4	Pilot ports 12, 14
39908	39909	G1	G ¹ / ₂	G ¹ / ₈

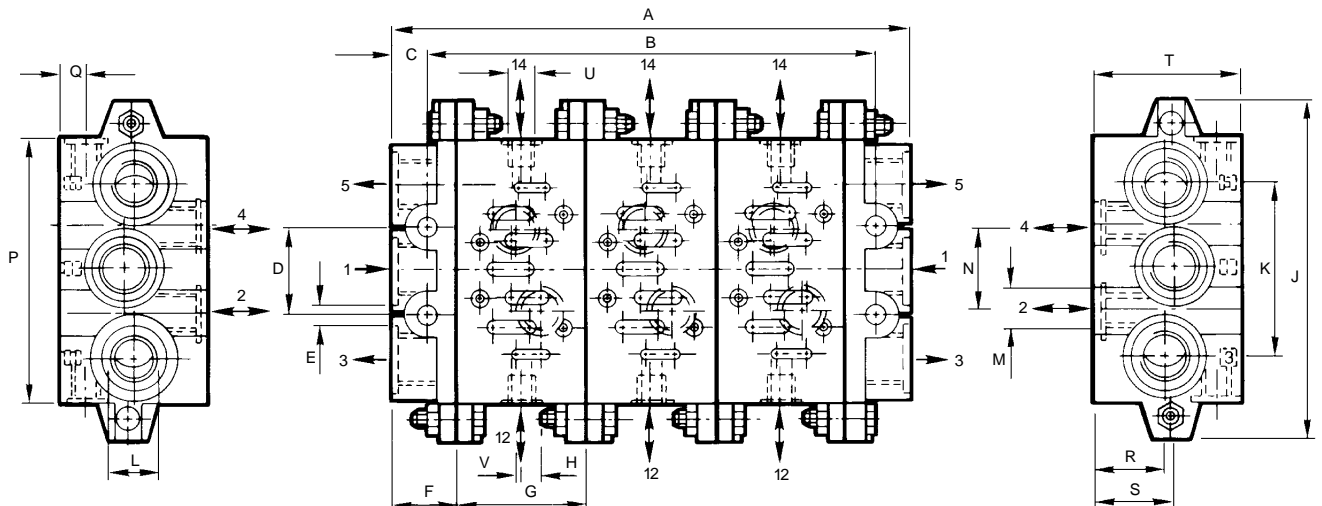

Dimensions (mm)

No. of Bases	A	B	C	D	ØE	F	G	H	J	K	L	M	N	P	Q	R	S	T	U	V
2	202	175																		
3	273	243																		
4	344	314	15	52	12	30	71	8	190	104	G1	G ¹ / ₂	38	140	10	31	34	56	G ¹ / ₈	6
5	415	385																		
6	486	456																		

Each valve in the manifold requires its own manifold block, which incorporates bottom entry G¹/₂ cylinder ports and side entry G¹/₈ pilot ports.

The end plate kit features, 3-off G1 side ports for inlet and exhaust facilities. The unwanted ports may be plugged.

Assembly of manifolds is simple, each manifold is supplied complete with 'O' ring seals and 2 assembly bolts which locate into integral lugs on each manifold or end plate.

I.S.O. Valves

VDMA I.S.O Sub base I.S.O. Size 1, 2 & 3 Form 'A'

Side ported

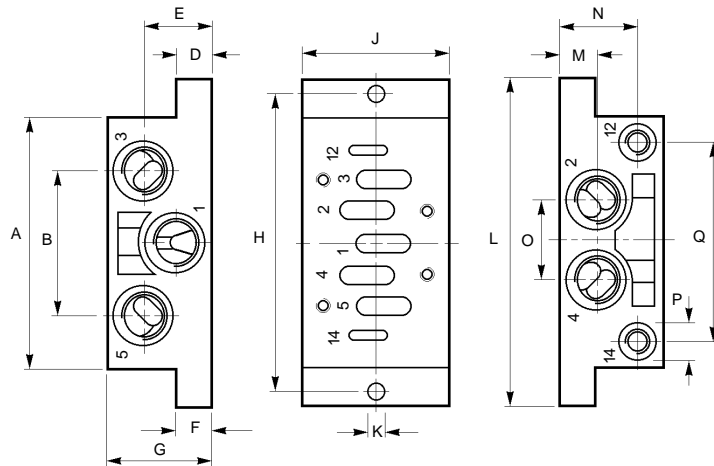

Part nos., dimensions (mm)

Part no.	I.S.O. Size	Port Size	A	B	D	E	F	G	H	J	K	L	M	N	O	P	Q
19704	1	G ¹ / ₄	84	43	10,5	21,5	10	32	98	48	5,5	110	10,5	23,5	24	G ¹ / ₈	58
29704	2	G ³ / ₈	95	56	14,0	26,0	13	40	112	57	6,6	124	14,0	30,0	30	G ¹ / ₈	74
39704	3	G ¹ / ₂	119	68	17,0	17,0	18	32	136	71	6,6	149	17,0	22,0	32	G ¹ / ₈	90

VDMA I.S.O Sub base I.S.O. Size 1, 2 & 3 Form 'B'

Bottom ported

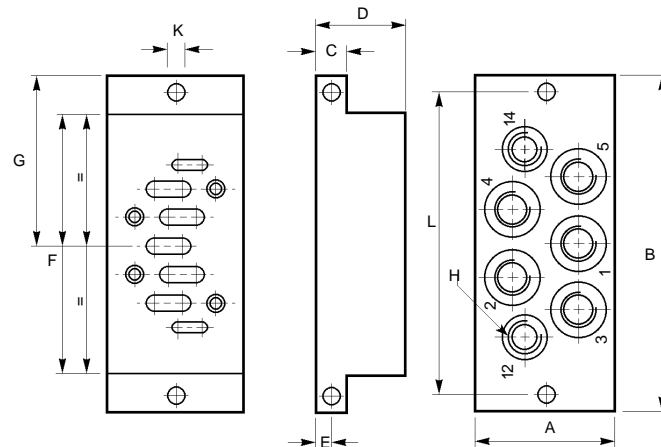

Part nos., dimensions (mm)

Part no.	I.S.O. Size	Port Size	A	B	C	D	E	F	G	H	K	L
19804	1	G ¹ / ₄	46	110	10	30	5,0	84	55,0	G ¹ / ₈	5,5	98
29804	2	G ³ / ₈	56	124	13	35	6,5	95	62,0	G ¹ / ₈	6,6	112
39804	3	G ¹ / ₂	71	149	18	32	9,0	119	74,5	G ¹ / ₈	6,6	136

VDMA I.S.O Size 1 and 2 Manifolds

Part no.

I.S.O. Size	Manifold kit	End plate kit
1	19908	19909
2	29908	29909

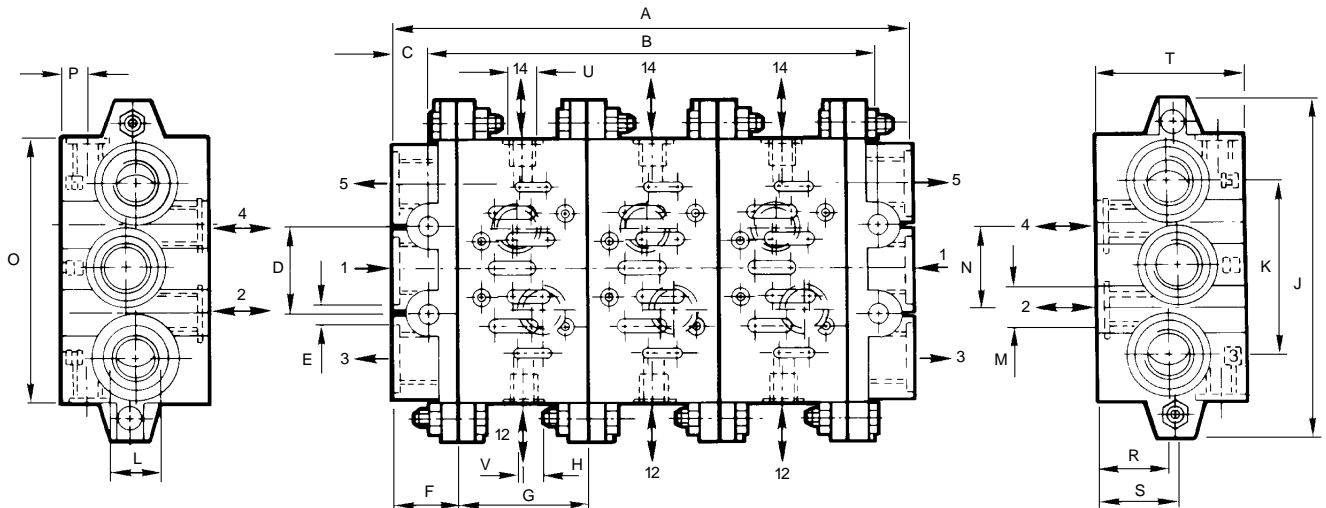

Dimensions (mm)

I.S.O. size	No. of bases	A	B	C	D	ØE	F	G	H	J	K	L (G)	M (G)	N	O	P	R	S	T	U (G)	V
1	2	130	108	11	28	7	22	43	7,5	110	56	$\frac{3}{8}$	$\frac{1}{4}$	26	85	8,5	21	24	46	$\frac{1}{8}$	1,5
1	3	173	151	11	28	7	22	43	7,5	110	56	$\frac{3}{8}$	$\frac{1}{4}$	26	85	8,5	21	24	46	$\frac{1}{8}$	1,5
1	4	216	194	11	28	7	33	43	7,5	110	56	$\frac{3}{8}$	$\frac{1}{4}$	26	85	8,5	21	24	46	$\frac{1}{8}$	1,5
1	5	259	237	11	28	7	22	43	7,5	110	56	$\frac{3}{8}$	$\frac{1}{4}$	26	85	8,5	21	24	46	$\frac{1}{8}$	1,5
1	6	302	280	11	28	7	22	43	7,5	110	56	$\frac{3}{8}$	$\frac{1}{4}$	26	85	8,5	21	24	46	$\frac{1}{8}$	1,5
2	2	164	138	13	35	9	26	56	6,0	135	68	$\frac{1}{2}$	$\frac{3}{8}$	30	100	9,0	22	24	47	$\frac{1}{8}$	5,0
2	3	220	194	13	35	9	26	56	6,0	135	68	$\frac{1}{2}$	$\frac{3}{8}$	30	100	9,0	22	24	47	$\frac{1}{8}$	5,0
2	4	276	250	13	35	9	26	56	6,0	135	68	$\frac{1}{2}$	$\frac{3}{8}$	30	100	9,0	22	24	47	$\frac{1}{8}$	5,0
2	5	322	305	13	35	9	26	56	6,0	135	68	$\frac{1}{2}$	$\frac{3}{8}$	30	100	9,0	22	24	47	$\frac{1}{8}$	5,0
2	6	388	362	13	35	9	26	56	6,0	135	68	$\frac{1}{2}$	$\frac{3}{8}$	30	100	9,0	22	24	47	$\frac{1}{8}$	5,0
3	2	202	172	15	52	12	30	71	8,0	190	104	1	$\frac{1}{2}$	38	140	10	31	34	56	$\frac{1}{8}$	6,0
3	3	273	243	15	52	12	30	71	8,0	190	104	1	$\frac{1}{2}$	38	140	10	31	34	56	$\frac{1}{8}$	6,0
3	4	344	314	15	52	12	30	71	8,0	190	104	1	$\frac{1}{2}$	38	140	10	31	34	56	$\frac{1}{8}$	6,0
3	5	415	385	15	52	12	30	71	8,0	190	104	1	$\frac{1}{2}$	38	140	10	31	34	56	$\frac{1}{8}$	6,0
3	5	486	456	15	52	12	30	71	8,0	190	104	1	$\frac{1}{2}$	38	140	10	31	34	56	$\frac{1}{8}$	6,0

VDMA I.S.O Size 3 Manifold
G^{3/4} Cylinder ports (side ports only)

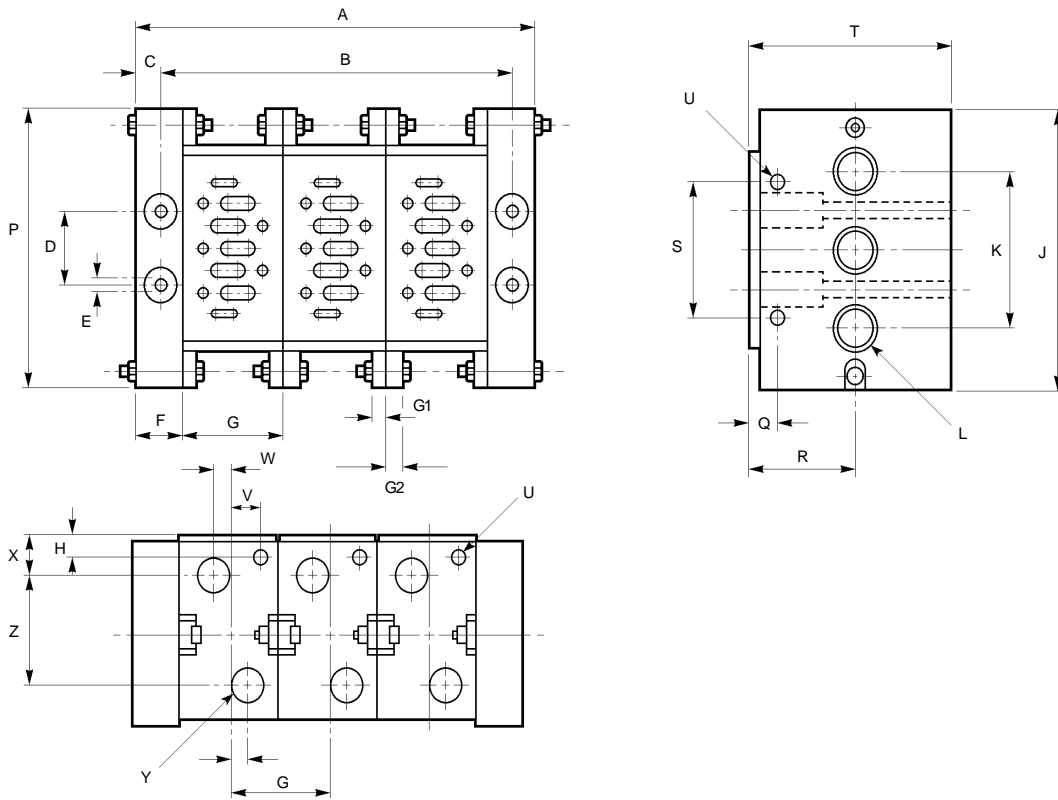

Dimensions (mm)

No. of Bases	A	B	C	D	ØE	F	G	G1	G2	H	J	K	L	M	N	P	Q	R	S	T
2	204	172																		
3	275	243																		
4	346	314	16	52	12	31	71	8	12	14,5	190	104	91	G ^{1/2}	72	190	4,5	66,5	90	131,5
5	417	385																		
6	488	456																		

No. of Bases	U	V	W	X	Y
2					
3					
4	G ^{1/8}	19,5	12,5	27,5	G ^{3/4}
5					
6					

Part no.

Manifold kit	End plate kit	Ports 1, 3, 5	Ports 2, 4	Pilot ports 12, 14
39903	39907	G1	G ^{3/4}	G ^{1/8}

Note: For G^{1/2} bottom ported manifolds see page 23

Manifold Adaptor Plates I.S.O. Size 1, 2, 3 & 4

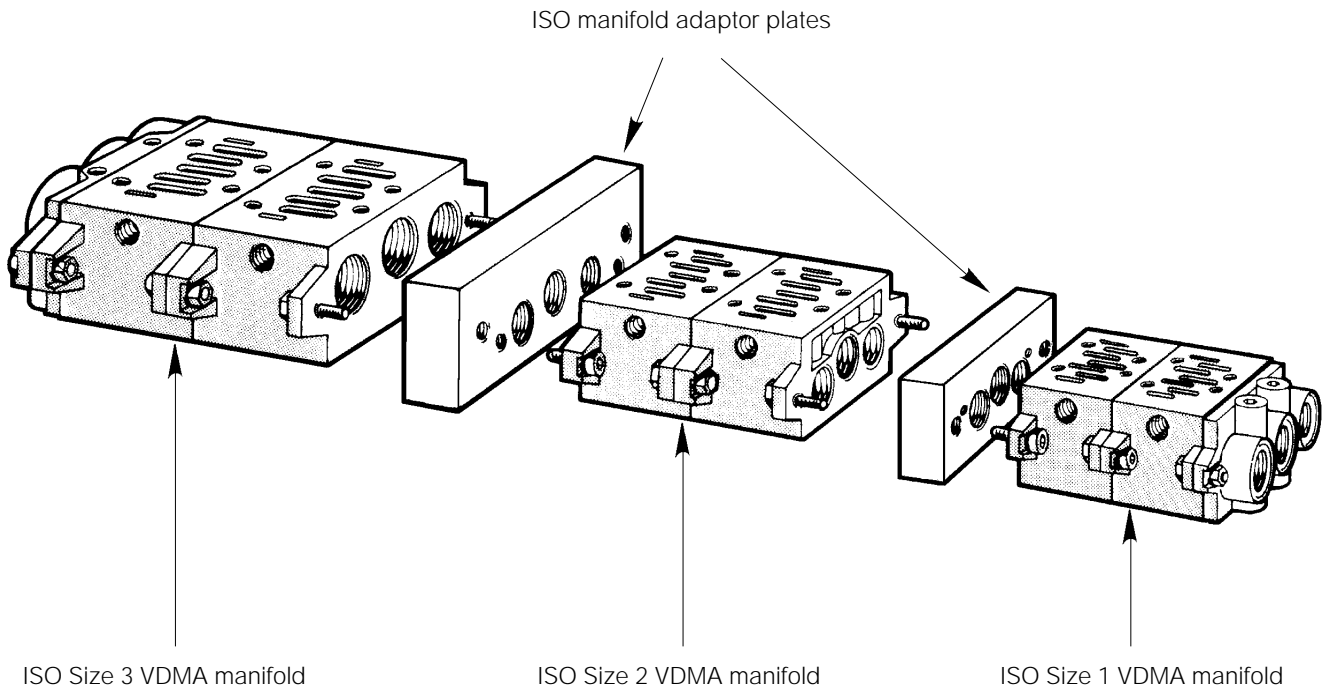

ISO Manifold Adaptor plates enable ISO VDMA manifolds of different sizes to be joined together, so that the manifold may be exactly tailored to suit the specific flow requirements of each part of an application.

A manifold may have ISO size 3 valves at one end, ISO size 2 valves in the middle, and ISO size 1 valves at the other end, all fed from the same inlet.

Part no.

I.S.O. Size	Part no.
1 to 2	19930
2 to 3	29930
3 to 4	39930
1 to 3	19931