







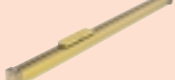

Associated ranges

Series	Body material
 <p>KA/8000, .../M Stainless steel tie-rod cylinders (ISO/VDMA) Double acting Ø 32 to 200 mm 216</p>	<p>Stainless steel Aluminium</p> <p>●</p>
 <p>KM/8000/M Stainless steel roundline cylinders (ISO) Double acting Ø 12 to 25 mm 220</p>	<p>●</p>
 <p>KM/55001/M Stainless steel (Clean line) roundline cylinders (ISO) Double acting Ø 32 to 125 mm 224</p>	<p>●</p>
 <p>VM/46000/M Lintra® Corrosion-resistant rodless cylinders Double acting Ø 20 to 80 mm 228</p>	<p>●</p>
 <p>KM/31000 Serviceable air bellows Single acting Ø 8 to 14½" 230</p>	<p>●</p>
 <p>F22, R22, L22 Ported filters, pressure regulators, lubricators ½" PTF 232</p>	<p>●</p>
 <p>R38, B38 Pressure regulators, filter-lubricators ¼" PTF, ½" PTF 234</p>	<p>●</p>
 <p>Stainless steel push-in tube fittings Metric Ø 4 ... 12 mm O/D tube 236</p>	<p>●</p>
 <p>61 Series Ball valves ¼" ... 1" BSPP 238</p>	<p>●</p>

Stainless steel tie-rod cylinders (ISO/VDMA)

KA/8000, .../M

Double acting

Ø 32 to 200 mm

Mountings

Ø	B, G	C	D	F	S	SW	UH	Bracket for switches #
32	KQA/8032/22	KQA/8032/21	KQA/8032/23	KQM/55433/25	KQA/8032/41	M/P72288	KQA/8032/40	QM/27/2/1
40	KQA/8040/22	KQA/8040/21	KQA/8040/23	KQM/55441/25	KQA/8040/41	M/P72289	KQA/8040/40	QM/27/2/1
50	KQA/8050/22	KQA/8050/21	KQA/8050/23	KQM/55451/25	KQA/8040/41	M/P72290	KQA/8050/40	QM/27/2/1
63	KQA/8063/22	KQA/8063/21	KQA/8063/23	KQM/55451/25	KQA/8063/41	M/P72291	KQA/8063/40	QM/27/2/1
80	KQA/8080/22	KQA/8080/21	KQA/8080/23	KQA/8080/25	KQA/8063/41	M/P72292	KQA/8080/40	QM/27/2/1
100	KQA/8100/22	KQA/8100/21	KQA/8100/23	KQA/8080/25	KQA/8100/41	M/P72293	KQA/8100/40	QM/27/2/1
125	KQA/8125/22	KQA/8125/21	KQA/8125/23	KQA/8125/25	KQA/8100/41	M/P72432	KQA/8125/40	QM/27/2/1
160	-	-	-	-	-	-	-	QM/27/2/1
200	-	-	-	-	-	-	-	QM/27/2/1

Please see next page for details of mountings.
For use with switches M/50

Standard cylinders

KA/8000, KA/8000/M

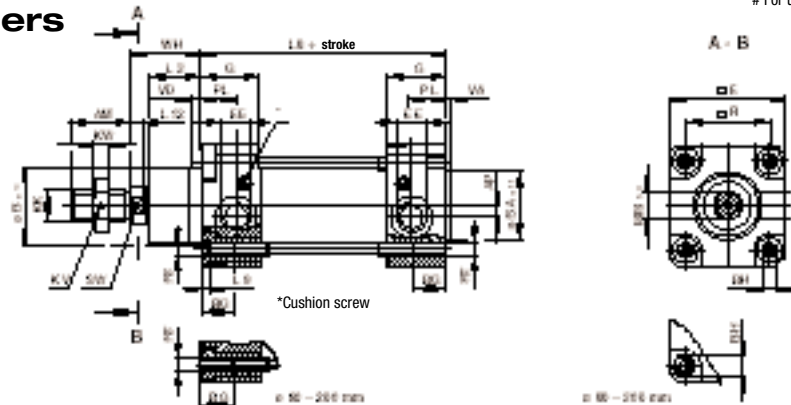

Ø	AM	AP	Ø B e11	Ø BA e11	BG	BH (A/F)	□ E	EE	G	KK	KV (A/F)	KW	L2
32	22	3,5	30	30	18	6	47	G 1/8	27,5	M10x1,25	17	5	20
40	24	4,5	35	35	18	6	53	G 1/4	32	M12x1,25	19	6	22
50	32	6	40	40	18	8	65	G 1/4	31	M16x1,5	24	8	27
63	32	10	45	45	17,5	8	75	G 3/8	33	M16x1,5	24	8	29
80	40	8,5	45	45	21,5	19	95	G 3/8	33	M20x1,5	30	10	33
100	40	9	55	55	21,5	19	115	G 1/2	37	M20x1,5	30	10	36
125	54	10	60	60	32	24	140	G 1/2	46	M27x2	41	13,5	45
160	72	18	65	65	28,5	32	180	G 3/4	50	M36x2	55	18	58
200	72	18	75	75	28,5	32	220	G 3/4	50	M36x2	55	18	67
Ø	L8	L9	L12	Ø MM t9	PL	□ R	RT	SW (A/F)	VA	VD	WH	kg at 0 mm	kg per 25 mm
32	94	4	6	12	13	32,5	M 6	10	3	6	26	1,12	0,06
40	105	4	6,5	16	15	38	M 6	13	3,5	6	30	1,65	0,08
50	106	5	8	20	18,5	46,5	M 8	17	3,5	6	37	2,57	0,13
63	121	5	8	20	19	56,5	M 8	17	4	6	37	3,95	0,14
80	128	-	10	25	19	72	M 10	22	4	6	46	6,64	0,30
100	138	-	10	25	20,5	89	M 10	22	4	6	51	10,67	0,34
125	160	-	13	32	20,5	110	M 12	27	6	15,5	65	20,82	0,51
160	180	-	16	40	21	140	M 16	36	4	15	80	37,3	0,88
200	180	-	16	40	21	175	M 16	36	5	15	95	59,0	1,14

Cylinder variants

KA/8000/JM – Cylinders with double ended piston rod

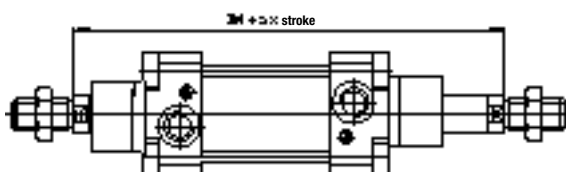

Ø	ZM	kg at 0 mm	kg per 25 mm
32	146	1,17	0,08
40	165	1,80	0,12
50	180	2,81	0,19
63	195	4,22	0,20
80	220	7,18	0,40
100	240	11,21	0,44
125	290	21,94	0,67
160	340	39,54	1,13
200	370	61,39	1,39

Stainless steel tie-rod cylinders (ISO/VDMA)

KA/8000, .../M

Double acting

Ø 32 to 200 mm

Mounting

Rear flange – B
 Front flange – G
 ISO 6431 and
 VDMA 24562 Part 2

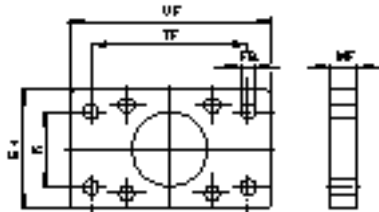

Ø	E1	Ø FB	MF	R	TF	UF	kg
32	50	7	10	32	64	80	0,26
40	55	9	10	36	72	90	0,31
50	65	9	12	45	90	110	0,56
63	75	9	12	50	100	125	0,73
80	100	12	16	63	126	154	1,73
100	120	14	16	75	150	186	2,51
125	140	16	20	90	180	224	4,48

Foot – C
 ISO 6431 and
 VDMA 24562 Part 2

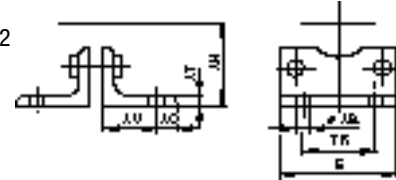

Ø	Ø AB	AH	AO	AT	AU	E	TR	kg
32	7	32	11	4	24	48	32	0,22
40	9	36	12	5	28	53	36	0,31
50	9	45	13	5	32	64	45	0,43
63	9	50	13	5	32	74	50	0,49
80	12	63	19	6	41	98	63	1,06
100	14	71	19	6	41	115	75	1,25
125	16	90	25	7	45	140	90	1,90

Piston rod clevis – F

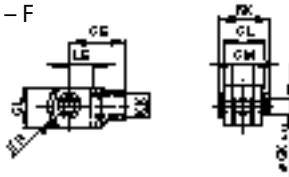

Thread	CE	Ø CK h11	CL	CM	ER	LE	RK	kg
M10x1,25	40	10	20	10	16	20	28	0,09
M12x1,25	48	12	24	12	19	24	32	0,13
M16x1,5	64	16	32	16	25	32	41,5	0,33
M20x1,5	80	20	40	20	32	40	50	0,67
M27x2	110	30	55	30	45	54	62	1,35

Rear clevis – D
 ISO 6431 and
 VDMA 24562 Part 2

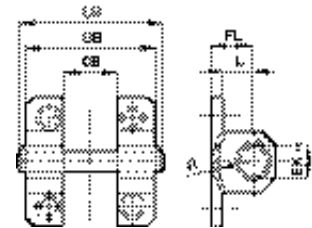

Ø	CB	Ø EK h8	FL	L	LH	MR	UB	kg
32	26	10	22	13	52	9	45	0,13
40	28	12	25	16	60	12	52	0,20
50	32	12	27	17	68	12	60	0,31
63	40	16	32	22	79	15	70	0,54
80	50	16	36	22	99	15	90	0,95
100	60	20	41	27	119	20	110	1,06
125	70	25	50	31	140	25	130	2,44

Stainless steel tie-rod cylinders (ISO/VDMA)

KA/8000, .../M

Double acting

Ø 32 to 200 mm

Trunnion support – S
VDMA 24562
Part 2

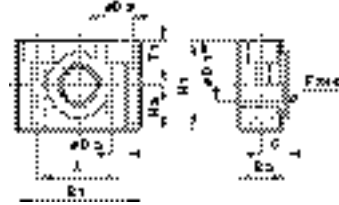

Ø	A	B1	B2	C	Ø H7	Ø D2	Ø D3	fx45°	H1	H2	T1	kg
32	32	46	18	10,5	12	6,6	11	1	30	15	6,8	0,27
40	36	55	21	12	16	9	15	1,6	36	18	9	0,42
50	36	55	21	12	16	9	15	1,6	36	18	9	0,42
63	42	65	23	13	20	11	18	1,6	40	20	11	0,59
80	42	65	23	13	20	11	18	1,6	40	20	11	0,59
100	50	75	28,5	16	25	14	20	2	50	25	13	0,92
125	50	75	28,5	16	25	14	20	2	50	25	13	0,92

For use with mountings style H, FH and UH. Stainless steel, weight on request

Adjustable centre trunnion – UH (for tie rod types)
ISO 6431 and VDMA 24562 Part 2



Ø	L	R	Ø TD e9	TL	TM h14	UW	XV min.	XV max.	kg
32	20	1	12	12	50	50	66	80	0,16
40	24	1,6	16	16	63	58	76	89	0,35
50	28	1,6	16	16	75	70	82	98	0,65
63	28	1,6	20	20	90	80	88	107	0,85
80	28	1,6	20	20	110	100	97	123	1,20
100	38	2	25	25	132	126	112	128	2,30
125	50	2	25	25	160	152	136	154	3,30

It is most important that the locking screws which secure the mounting to the tie rod are tightened to the torque figures shown in the table below. For maximum energy input, consult our Technical Service.

Wide hinge – SW

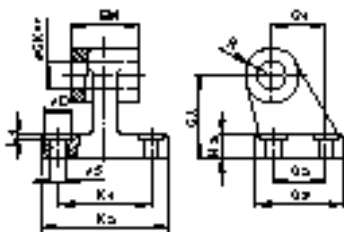

Ø	CA	Ø CK H9	Ø D	H2	EM	G1	G2	G3	K1	K2	L1	R	Ø S	kg
32	32	10	11	8	26	21	18	31	38	51	1,6	10	6,6	0,15
40	36	12	11	10	28	24	22	35	41	54	1,6	11	6,6	0,21
50	45	12	15	12	32	33	30	45	50	65	1,6	13	9	0,41
63	50	16	15	12	40	37	35	50	52	67	1,6	15	9	0,53
80	63	16	18	14	50	47	40	60	66	86	2,5	15	11	0,82
100	71	20	18	15	60	55	50	70	76	96	2,5	19	11	1,22
125	90	25	20	20	70	70	60	90	94	124	–	22	14	3,50

QM/27/2/1 – Switch mounting brackets

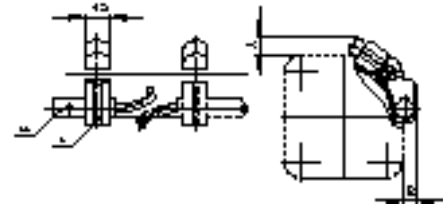

* Switch mounting bracket
** Magnetically operated switch

Switches - M/50

Ø	A	B	kg
32	9	7	0,01
40	8	8	0,01
50	7	5	0,01
63	7	7	0,01
80	7	4	0,01
100	2	2	0,01
125	-4	-3	0,01
160	-10	-9	0,01
200	-17	-14	0,01

Stainless steel roundline cylinders (ISO)

KM/8000/M

Double acting, ISO 6432

Ø 12 to 25 mm

Mountings

Ø	B, G	C	F	L	N	Switch mounting brackets # > 15 mm stroke	Switch mounting brackets # < 15 mm stroke
12	M/P72405	M/P72403	KQM/8012/25	KQM/8012/24	M/P72398	QM/33/012/22	QM/33/010/23
16	M/P72405	M/P72403	KQM/8012/25	KQM/8012/24	M/P72398	QM/33/016/22	QM/33/016/23
20	M/P72406	M/P72404	KQM/8020/25	KQM/8020/24	M/P72399	QM/33/020/22	QM/33/020/23
25	M/P72406	M/P72404	KQM/55433/25	KQM/8020/24	M/P72399	QM/33/025/22	QM/33/025/23

Please see next page for details of mountings.

For use with switches M/50.

Standard cylinders

KM/8000/M

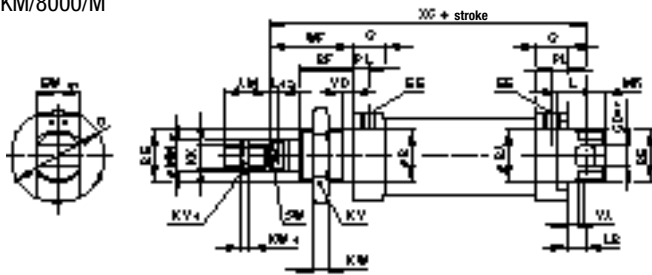

Cylinder variants

KM/8021/M, KM/8026/M – Cylinders with adjustable cushioning

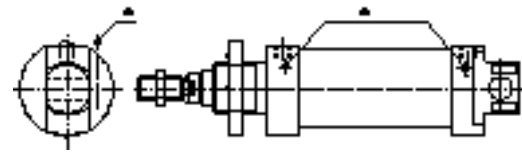

* Cushion screws

Ø	AM	Ø B/BA	BE	BF	Ø CD H9	Ø D	EE	EW -0,1	G	KK	KV (A/F)	KV1 (A/F)	KW
12	16	16	M16x1,5	17	6	20	M5	11,9	9,5	M6	22	10	5
16	16	16	M16x1,5	17	6	20	M5	11,9	9,5	M6	22	10	5
20	20	22	M22x1,5	20	8	30	G1/8	15,9	15	M8	27	13	8
25	20	22	M22x1,5	22	8	30	G1/8	15,9	15	M10x1,25	27	17	8
Ø	KW1	L	L12	LB	Ø MM h9	MR	PL	SW (A/F)	WF	VAVD	XC	kg at 0 mm	kg per 25 mm
12	3	9	3	3	6	8	5,5	5	22	2	75	0,116	0,011
16	3	9	3	4	6	7	5,5	5	22	2	82	0,137	0,012
20	4	12	3	3	8	11	8	7	24	2	95	0,306	0,018
25	5	12	4	7	10	9	8	9	28	2	104	0,383	0,028

Cylinder variants

KM/8000/MF – Cylinders with flat rear cover

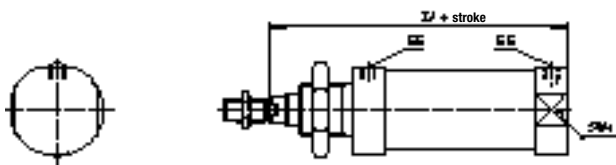

Ø	EE	ZJ	SW1 (A/F)
12	M5	72	17
16	M5	78	17
20	G1/8	92	27
25	G1/8	97	27

KM/8000/JM – Cylinders with double ended piston rod

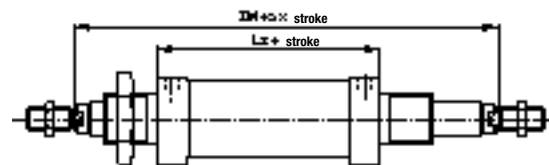

Ø	L8	ZM
16	56	100
20	68	116
25	69	125

Stainless steel roundline cylinders (ISO)

KM/8000/M

Double acting, ISO 6432

Ø 12 to 25 mm

Front flange – G
Rear flange – B
ISO 6432

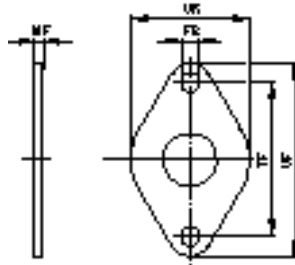

Ø	Ø FB	MF	TF	UF	UR	kg
12 + 16	5,5	4	40	52	30	0,03
20 + 25	6,6	5	50	66	40	0,05

Foot – C
ISO 6432

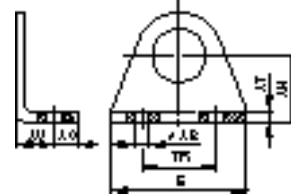

Ø	Ø AB	AH	AO	AT	AU	E	TR	kg
12 + 16	5,5	20	6	3	13	43	32	0,03
20 + 25	6,6	25	7,5	4	16	53	40	0,06

Piston rod clevis - F
ISO 8140

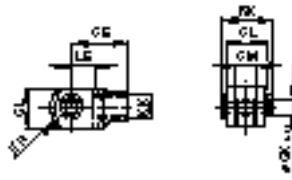

Thread KK	CE	Ø CK h11	CL	CM	ER	LE	FK	kg
M6	24	6	12	6	9,5	12	17,5	0,02
M8	32	8	16	8	13	16	22	0,06
M10 x1,25	40	10	20	10	16	20	28	0,10

Rear hinge – L

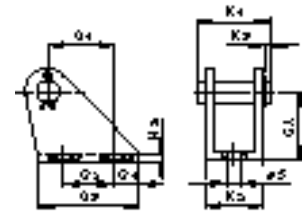

Ø	CA	G1	G2	G3	G4	H2	K1	K2	K3	Ø S	kg
12	20	18,5	15	30	8	1,5	20	15	3	5,5	0,04
16	20	18,5	15	30	8	1,5	20	15	3	5,5	0,04
20	25	20	15	35	10	2	25	20,5	3	6,6	0,08
25	25	20	15	35	10	2	25	20,5	3	6,6	0,08

Nose nut - N

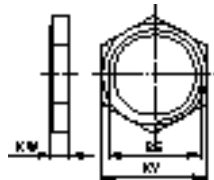

Ø	BE	KV (AF)	KW	kg
12 + 16	M16x1,5	22	5	0,01
20 + 25	M22x1,5	27	8	0,02

Brackets ≥ 15 mm stroke

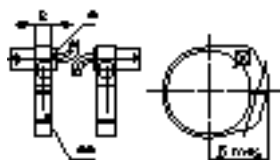

* Magnetically operated switch
** Switch mounting bracket

Ø	B	R max.	kg
12	8	18	0,01
16	10	20	0,01
20	10	22	0,01
25	10	24	0,01

Brackets < 15 mm stroke

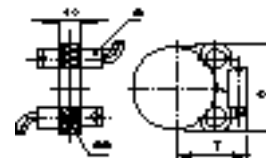

* Magnetically operated switch
** Switch mounting bracket

Ø	S	T	kg
12	28,5	21,5	0,01
16	29,5	23,5	0,01
20	29,5	26	0,01
25	31,5	28,5	0,01

Cylinder sizing and speed control

CYLINDER SIZING FOR THRUST

The theoretical thrust (outstroke) or pull (instroke) of a cylinder is calculated by multiplying the effective area of the piston by the working pressure. The effective area for thrust is the full area of the cylinder bore. The effective area for pull is reduced by the cross section area of the piston rod.

Current practice specifies bore (D) and piston rod diameter (d) in millimetres and working pressure (P) in bar gauge. In the formula, P is divided by 10 to express pressure in Newtons per square millimetre (1 bar = 0,1 N/mm²)

Piston and rod diameters

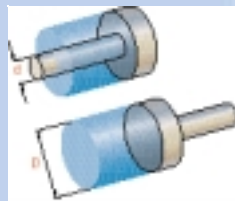

The theoretical force (F) is given by

$$\text{Thrust } F = \frac{\pi D^2 P}{40} \text{ N}$$

$$\text{Pull } F = \frac{\pi(D^2 - d^2)P}{40} \text{ N}$$

Where

D = Cylinder bore in millimetres

d = Piston rod diameter in millimetres

P = Pressure in bar

F = Thrust or Pull in Newtons

Example:

Find the theoretical thrust and pull of a 50 mm bore cylinder supplied with a pressure of 8 bar

$$\text{Thrust } F = \frac{\pi 50^2 \cdot 8}{40} = 1571 \text{ N}$$

$$\text{Pull } F = \frac{\pi(50^2 - 20^2) \cdot 8}{40} = 1319 \text{ N}$$

Table of consumption

Bore mm	Rod mm	Push stroke consumption dm ³ /mm of stroke at 6 bar	Pull stroke consumption dm ³ /mm of stroke at 6 bar	Combined consumption dm ³ /mm of stroke/cycle
12	6	0,00079	0,00065	0,00144
16	6	0,00141	0,00121	0,00262
20	8	0,00220	0,00185	0,00405
25	10	0,00344	0,00289	0,00633
32	12	0,00563	0,00484	0,01047
40	16	0,00880	0,00739	0,01619
50	20	0,01374	0,01155	0,02529
63	20	0,02182	0,01962	0,04144
80	25	0,03519	0,03175	0,06694
100	25	0,05498	0,05154	0,10652
125	32	0,08590	0,08027	0,16617
160	40	0,14074	0,13195	0,27269
200	40	0,21991	0,21112	0,43103
250	50	0,34361	0,32987	0,67348

Table of thrust and pulls, double acting cylinders

Cylinder bore mm (inches)	Piston rod diameter mm (inches)	Thrust N at 6 bar	Pull N at 6 bar
12	6	67	50
16	6	120	103
20	8	188	158
25	10	294	246
32	12	482	414
40	16	753	633
50	20	1178	989
63	20	1870	1681
80	25	3015	2721
100	25	4712	4418
125	32	7363	6881
160	40	12063	11309
200	40	18849	18095

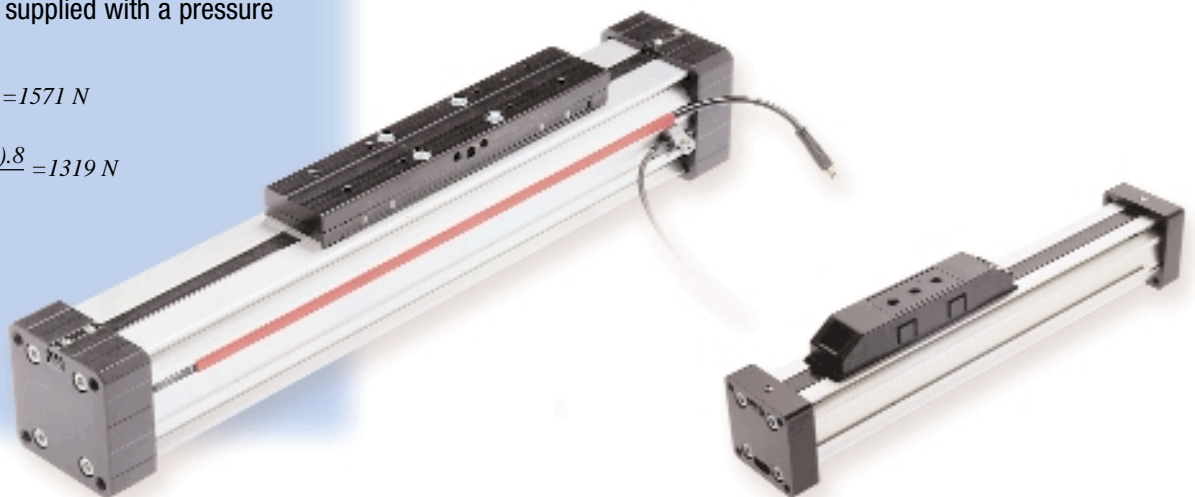

Stainless steel (Clean line) roundline cylinders (ISO)

KM/55001/M

Double acting, ISO 6431

Ø 32 to 125 mm

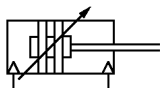

Clean line design

High corrosion and acid resistance

Magnetic piston as standard

Conforms to ISO 6431

Suitable for applications in the food industry

Adjustable cushioning

Nose mounting nut and piston rod lock nut as standard

Special wiper/seal as standard

Technical data

Medium:

Compressed air, filtered, lubricated or non-lubricated

Operation:

Double acting with magnetic piston, adjustable cushioning

Operating pressure:

1 to 10 bar

Operating temperature:

-20°C to +80°C

Maximum 150°C with heat resistant seals

Consult our Technical Service for use below +2°C

Strokes:

Non-standard strokes

(1600 mm max.) available.

Materials

Barrel: X5 Cr Ni 18 10 (1.4301, AISI 304)

End covers: X10 Cr Ni S 18 9 (1.4305, AISI 303)

Piston rod: X10 Cr Ni 18 9 (1.4305, AISI 303)

O-rings: FPM

Piston seals: polyurethane

Cushion seals: nitrile rubber

Standard models

Ø	Piston rod Ø	Port size	Model Magnetic	Service kit
32	12	G1/8	KM/55033/M/*	KQM/55032/00
40	16	G1/4	KM/55041/M/*	KQM/55040/00
50	20	G1/4	KM/55051/M/*	KQM/55050/00
63	20	G3/8	KM/55064/M/*	KQM/55063/00
80	25	G3/8	KM/55081/M/*	KQM/55080/00
100	25	G1/2	KM/55101/M/*	KQM/55100/00
125	32	G1/2	KM/55126/M/*	KQM/55125/00

* Insert stroke length in mm. Cylinder sizing and speed control see page 223

Options selector

★KM/55★**/★*/★**★

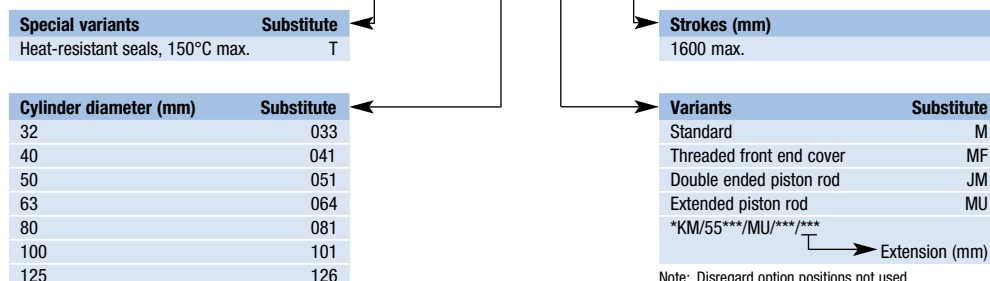

Note: Disregard option positions not used.

For combinations of cylinder variants consult our Technical Service.

Switches

	Model	Voltage V a.c.	V d.c.	Current max.	Output	Cable length	Cable type
With integral cable	M/50/LSU/*V	10 ... 240	10 ... 170	180 mA	–	2, 5, 10 m	PVC 2 x 0,25
	M/50/EAP/*V	–	10 ... 30	150 mA	PNP	2, 5, 10 m	PVC 3 x 0,25
With plug-in cable	M/50/LSU/CP	10 ... 60	10 ... 75	180 mA	Plug M8x1	~0,27 m	PVC 3 x 0,25
	M/50/EAP/CP	–	10 ... 30	150 mA	PNP, Plug M8x1	~0,27 m	PVC 3 x 0,25

*Insert cable length – 2, 5 or 10 m.

Note: Plug-in cable part number: M/P73001/5 (5m)

Stainless steel (Clean line) roundline cylinders (ISO)

KM/55001/M

Double acting, ISO 6431

Ø 32 to 125 mm

Mountings

Ø	C	F	G	H	L	N	Switch mounting brackets #
32	KQM/55433/21	KQM/55433/25	M/P34297	QM/55232/28	KQM/55032/24	M/P34276	QM/33/432/22
40	KQM/55441/21	KQM/55441/25	M/P34298	QM/55240/28	KQM/55040/24	M/P34277	QM/33/440/22
50	KQM/55451/21	KQM/55451/25	M/P34299	QM/55250/28	KQM/55050/24	M/P34278	QM/33/450/22
63	KQM/55464/21	KQM/55451/25	M/P34300	QM/55263/28	KQM/55063/24	M/P34278	QM/33/463/22
80	–	KQA/8080/25	–	QM/55480/28	KQM/55080/24	–	QM/33/480/22
100	–	KQA/8080/25	–	QM/55410/28	KQM/55100/24	–	QM/33/100/22
125	–	KQA/8125/25	–	QM/55125/28	KQM/55125/24	–	QM/33/125/22

Please see next page for details of mountings.

For switches M/50.

Standard cylinders

KM/55001/M

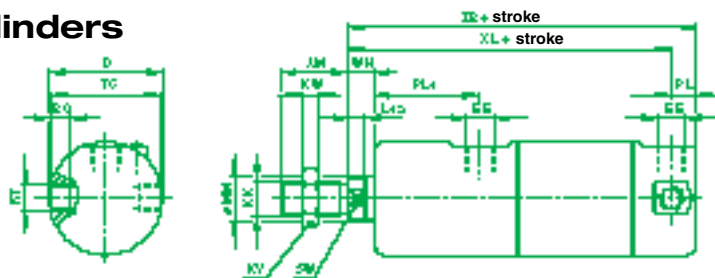

Ø	AM	BG	Ø D	EE	KK	KV (A/F)	KW	L12	Ø MM	PL
32	22	6	36	G 1/8	M10 x 1,25	17	5	6	12	9
40	24	8	44	G 1/4	M12 x 1,25	19	6	6,5	16	15
50	32	9,5	54	G 1/4	M16 x 1,5	24	8	8	20	12
63	32	10	68	G 3/8	M16 x 1,5	24	8	8	20	13
80	40	18	86	G 3/8	M20 x 1,5	30	10	10	25	16
100	40	22	106	G 1/2	M20 x 1,5	30	10	10	25	19
125	54	29	133	G 1/2	M27 x 2	41	13,5	13	32	17,5
Ø	PL1	RT	SW	TC	WH	XL	ZB	kg at 0 mm	kg per 25 mm	
32	39	M8 x 1	10	34,5	8	124,5	132	0,78	0,06	
40	50	M10 x 1	13	42	10	142	154	1,36	0,09	
50	50	M12 x 1,5	17	52	12	152	164	2,25	0,13	
63	51	M14 x 1,5	17	66	13	159	172	3,78	0,16	
80	47	M16 x 1,5	22	83,5	13	160	176	5,99	0,25	
100	47	M20 x 1,5	22	102,5	15	178	197	10,36	0,29	
125	62,5	M24 x 1,5	27	128,5	20	207,5	225	22,97	0,48	

Stainless steel (Clean line) roundline cylinders (ISO)

KM/55001/M

Double acting, ISO 6431

Ø 32 to 125 mm

Cylinder variants

KM/55001/JM – Cylinder with double-ended piston rod

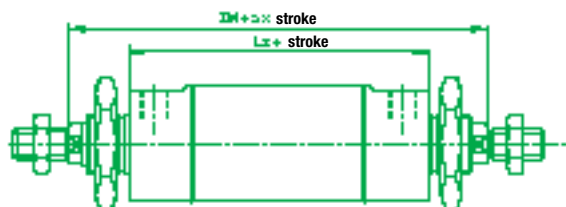

KM/55001/MF – Cylinder with threaded front end cover

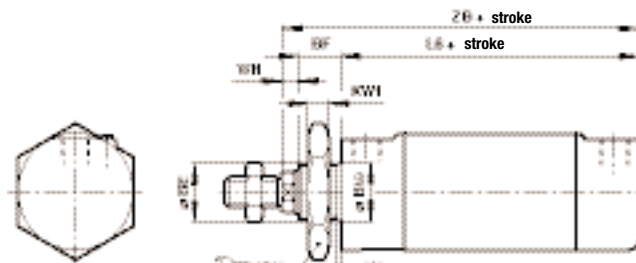

Ø	BE	BF	KV1	KW1	L8	TE	VA	ZM
32	M30 x 1,5	30	36	8	94	42,5	3	170
40	M38 x 1,5	35	46	10	109	50	3	199
50	M45 x 1,5	38	55	10	114	60	3	214
63	M45 x 1,5	38	55	10	121	74	3	223

KM/55001/M/R – Cylinder with rear eye mounting

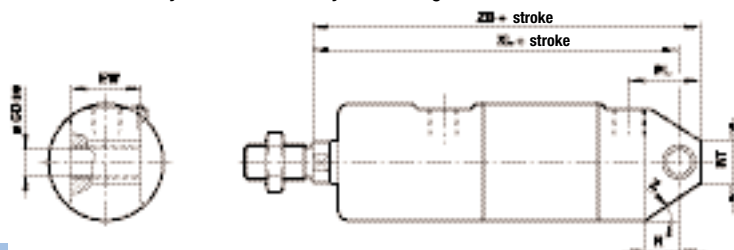

Ø	Ø CD	EW	PL	R	RT	XL	Z	ZB
32	10	25,8	29	14,5	19	142	20°	151
40	12	27,8	34	16	18	160	25°	172
50	12	31,7	33,5	19	24	170	30°	182
63	16	39,7	46	22	25,5	190	30°	205
80	16	49,7	65	24	41	210	30°	225
100	20	59,7	71	27	51	230	30°	250

M/55001/M/D2 – Cylinder with rear clevis mounting

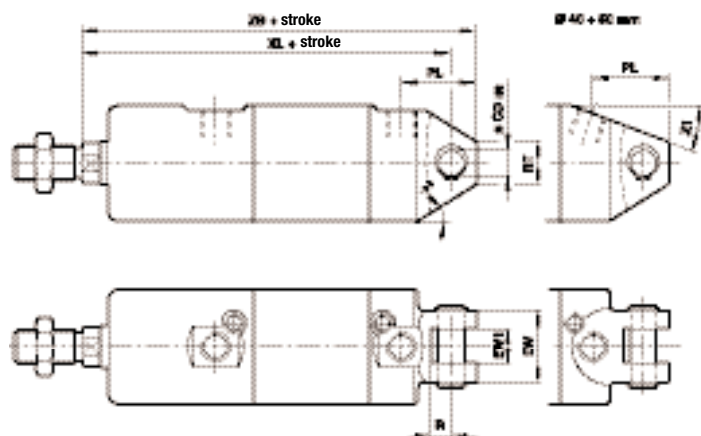

Ø	Ø CD ^{H9}	EW	EW1 ^{+0,2}	PL	R	RT	XL	Z	Z1	ZB
32	10	26	14	30,5	16,5	19	142	20°	–	151
40	12	32	16	36,5	19,5	18	160	25°	15°	172
50	12	41	21	36,5	21,5	24	170	30°	20°	182
63	16	41	21	46	23,5	25,5	190	30°	–	205

M/55001/M/UR – Cylinder with universal rear eye mounting

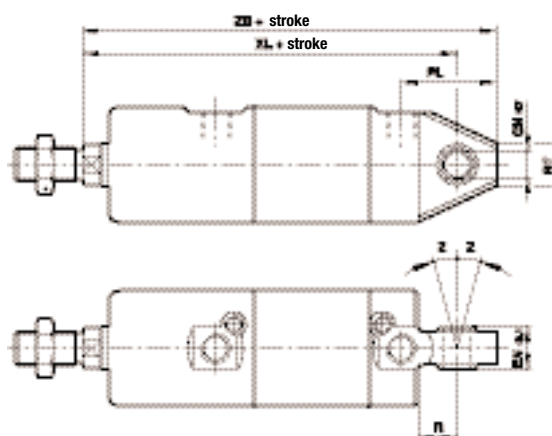

Ø	Ø CN ^{H7}	EN ^{-0,1}	PL	R	RT	XL	Z	ZB
32	10	14	36	14,5	17,5	142	13°	158
40	12	16	41	16	28,5	160	13°	178
50	16	21	42,5	19	34	170	13°	191
63	16	21	55	22	35,5	190	15°	213
80	20	25	78	24	37,5	210	15°	238
100	20	25	81	27	40,5	230	15°	260

Stainless steel (Clean line) roundline cylinders (ISO)

KM/55001/M

Double acting, ISO 6431

Ø 32 to 125 mm

Mountings

Piston rod clevis – F
Corresponds to DIN ISO 8140

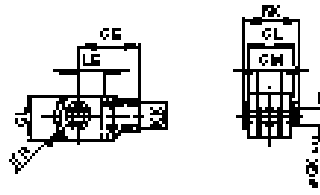

Ø	CE	Ø CK h11	CL	CM	ER	KK	LE	RK	kg
32	40	10	20	10	16	M10 x 1,25	20	28	0,09
40	48	12	24	12	19	M12 x 1,25	24	32	0,13
50	64	16	32	16	25	M16 x 1,5	32	41,5	0,33
63	64	16	32	16	25	M16 x 1,5	32	41,5	0,33
80	80	20	40	20	32	M20 x 1,5	40	58	0,67
100	80	20	40	20	32	M20 x 1,5	40	58	0,67
125	110	30	55	30	45	M27 x 2	54	72	1,35

Front flange – G, B

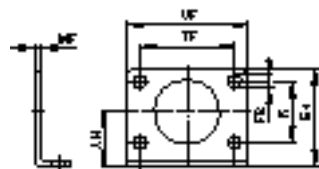

Ø	AH	E1	Ø FB	MF	R	TF	UF	kg
32	28	49	7	4	28	52	66	0,11
40	33	58	9	5	30	60	80	0,19
50	40	70	9	5	40	70	90	0,25
63	45	80	9	5	50	76	96	0,33

Foot – C

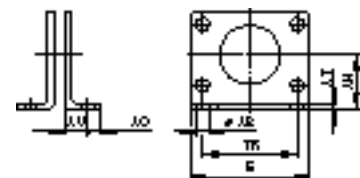

Ø	Ø AB	AH	AO	AT	AU	E	TR	kg
32	7	28	7	4	14	66	52	0,25
40	9	33	10	5	20	80	60	0,44
50	9	40	10	5	20	90	70	0,59
63	9	45	10	5	20	96	76	0,73

Central trunnion – H



Ø	Ø TD h9	TL	UT	kg
32	10	8	51	0,02
40	12	9,5	63	0,03
50	14	11	76	0,05
63	16	13	93	0,07
80	18	13	111,5	0,09
100	20	13	131,5	0,25
125	25	20	168,5	0,32

Lock nut – N

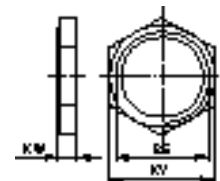

Ø	BE	KV	KW	kg
32	M30 x 1,5	36	8	0,03
40	M38 x 1,5	46	10	0,06
50	M45 x 1,5	55	10	0,08
63	M45 x 1,5	55	10	0,08
80	M55 x 1,5	60	13	0,25
100	M55 x 1,5	80	13	0,25

Rear hinge – L

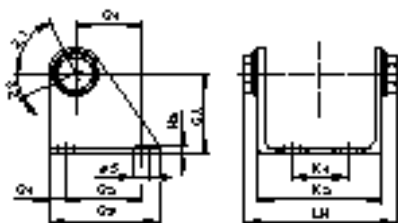

Ø	CA	G1	G2	G3	G4	Ø S	H2	K1	K2	LH	Z1	Z2
32	35	20	24	40	8	7	4	20	46,5	59,5	65°	36°
40	40	27	30	50	10	9	5	28	56,5	71	55°	32°
50	45	30	34	54	10	9	5	36	68,5	83	60°	30°
63	50	34	35	65	15	9	5	42	82,5	99	189°	25°
80	65	47,5	55	80	12,5	11	6	55	102,5	125,5	193°	27°
100	77	63	70	100	15	11	6	70	122,5	145,5	191°	25°
125	90	82,5	90	125	17,5	13,5	8	90	152,5	175,5	188°	22°

QM/33/**/22 – Switch mounting bracket

Ø 32 ... 80 mm

Ø 100 & 125 mm

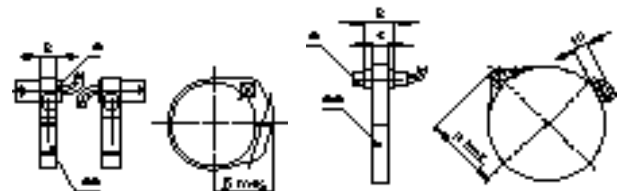

* Magnetically operated switches

** Bracket

Ø	B	R max.
32	10	29
40	10	32
50	10	38
63	10	46
80	12	54
100	10	59
125	10	72,5

LINTRA® Corrosion-resistant rodless cylinders

VM/46000

Double acting
 Ø 20 to 80 mm

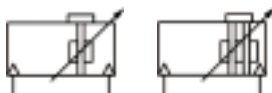
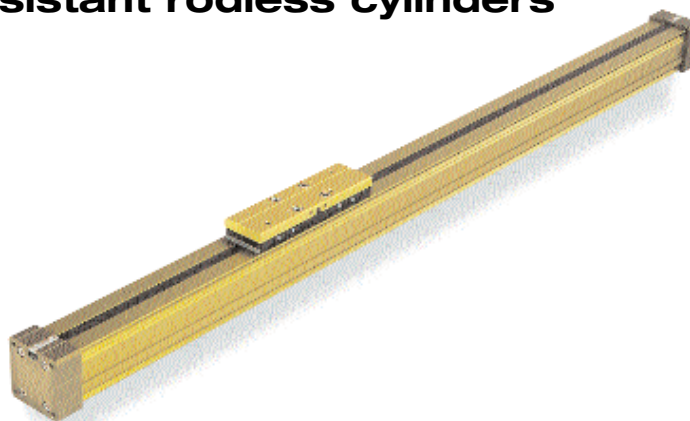

New lightweight design extrusion with integral slots for switch mounting

Capable of withstanding large bending moments and lateral forces

Built-in guidance with internal and adjustable external options

Technical data

Medium:

Compressed air, filtered and lubricated or non-lubricated

Operation:

VM/46000, VM/46100:

Double acting, adjustable cushioning

VM/46000/M, VM/46100/M:

Double acting, adjustable cushioning, magnetic piston

Operating pressure:

1 to 10 bar

Operating temperature:

-30°C to +80°C

Consult our Technical Service for use below +2°C

Strokes:

Made to order, 3500 mm max.

Materials

End covers: aluminium (HCR® coated*)

Carriage: aluminium (HCR® coated*)

Yoke: moulded plastic – Ø 20 mm, aluminium (HCR® coated*) – Ø 25 to 80 mm

Barrel: extruded aluminium alloy (HCR® coated*)

Sealing strip & piston seals: polyurethane

Cover strip: polyamide

Seals: nitrile rubber

*HCR®: High Technology Synergistic Coating

Standard models

Ø	Port size	Internal guide		Service kit	External guide		Service kit
		Non-magnetic	Magnetic		Non-magnetic	Magnetic	
20	G1/8	VM/46020/*	VM/46020/M/*	QM/46020/*/88	VM/46120/*	VM/46120/M/*	QM/46120/*/88
25	G1/8	VM/46025/*	VM/46025/M/*	QM/46025/*/88	VM/46125/*	VM/46125/M/*	QM/46125/*/88
32	G1/4	VM/46032/*	VM/46032/M/*	QM/46032/*/88	VM/46132/*	VM/46132/M/*	QM/46132/*/88
40	G1/4	VM/46040/*	VM/46040/M/*	QM/46040/*/88	VM/46140/*	VM/46140/M/*	QM/46140/*/88
50	G3/8	VM/46050/*	VM/46050/M/*	QM/46050/*/88	VM/46150/*	VM/46150/M/*	QM/46150/*/88
63	G1/2	VM/46063/*	VM/46063/M/*	QM/46063/*/88	VM/46163/*	VM/46163/M/*	QM/46163/*/88
80	G1/2	VM/46080/*	VM/46080/M/*	QM/46080/*/88	VM/46180/*	VM/46180/M/*	QM/46180/*/88

* Insert stroke length in mm. Cylinder sizing and speed control see page 223.

Note: Service kits are available in 1000 mm stroke multiples e.g. QM/46025/1000/88, QM/46025/2000/88 etc.

Options selector

VM/46****/*/*****

Guiding system	Substitute
Internal	0
External	1

Cylinder diameters (mm)	Substitute
20	20
25	25
32	32
40	40
50	50
63	63
80	80

Piston type	Substitute
Magnetic	M
Non-magnetic	None

Strokes (mm)
3500 max.

Note: Disregard option positions not used.

For combinations of cylinder variants consult our Technical Service.

Mounting

Ø	C	V
---	---	---



20	VQM/46020/21	VQM/46020/32
25	VQM/46025/21	VQM/46025/32
32	VQM/46032/21	VQM/46032/32
40	VQM/46040/21	VQM/46040/32
50	VQM/46050/21	VQM/46050/32
63	VQM/46063/21	VQM/46063/32
80	VQM/46080/21	VQM/46080/32

Switches

	Model	Voltage	Current	Output	Cable length	Cable type
		V a.c.	V d.c.	max.		
With integral cable	M/50/LSU/*V Reed	10 ... 240	10 ... 170	180 mA	–	2, 5, 10 m PVC 2 x 0,25
	M/50/EAP/*V Solid state	–	10 ... 30	150 mA	PNP	2, 5, 10 m PVC 3 x 0,25

*Insert cable length – 2, 5 or 10 m.



With plug-in cable	M/50/LSU/CP Reed	10 ... 60	10 ... 75	180 mA	Plug M8x1	5 m PVC 3 x 0,25
	M/50/EAP/CP Solid state	–	10 ... 30	150 mA	PNP, Plug M8x1	5 m PVC 3 x 0,25

Note: Plug-in cable part number: M/P73001/5 (5m) - Groove cover part number: M/P72725/1000

LINTRA® Corrosion-resistant rodless cylinders

VM/46000

Double acting

Ø 20 to 80 mm

Standard cylinders

VM/46000, VM/46000/M – Cylinders with internal guide

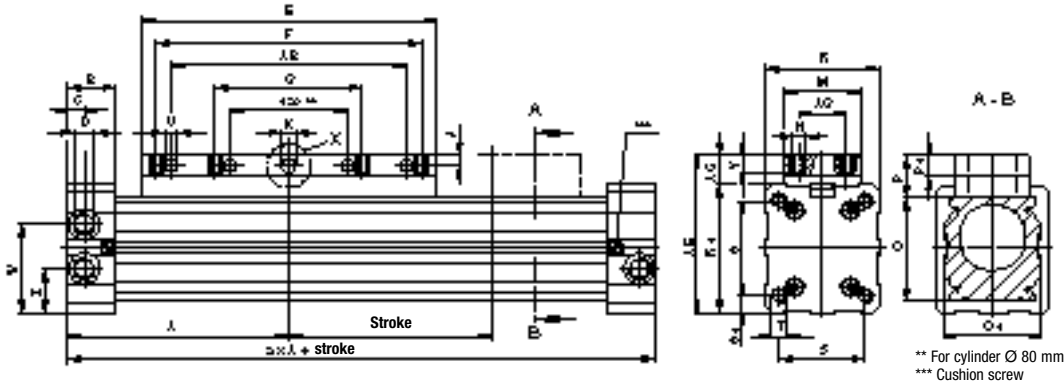

VM/46100, VM/46100/M – Cylinders with external guide

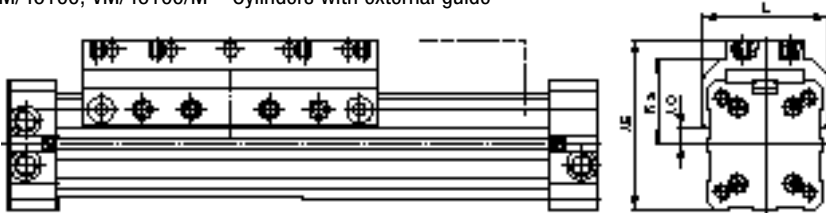

Ø	A	AB	AC	AE	AG	AO	B	C	D	E	F	G	J	K	M	N
20	85	– (60)	14	54 (59)	18 (6,5)	23	8	G1/8	110	80	40	3,5 (7,5)	Ø4,2 D7	27 (5,5)	M5	
25	100	– (70)	12	60 (67,5)	20 (9,5)	23	14,5	G1/8	130	90	45	– (5)	□ 4,5	32 (5,5)	M5	
32	120	– (90)	16	76 (82)	25 (15,5)	27	10,5	G1/4	160	120	60	– (5)	□ 6	45 (5,5)	M5	
40	150	– (120)	15	90 (97,5)	25 (16,5)	30	11,5	G1/4	215	160	80	– (5)	□ 6	45 (6,6)	M6	
50	180	– (160)	20	110 (117)	25 (24)	35	14	G3/8	250	190	95	– (6,5)	□ 8	50 (9)	M8	
63	215	– (190)	20	125 (137)	25 (25,5)	40	17	G1/2	320	240	120	– (7,5)	□ 8	50 (9)	M8	
80	260	240 (240)	24	154 (165)	25 (38)	45	17	G1/2	390	300	150	9 (10)	Ø12 E7	50 (12)	M10	
Ø	O	O1	P	P1	R	R1	R2	S	S1	T	ØU	W	Y	Z	kg at 0 mm	kg per 100 mm
20	32	32	18,5	–	40	40	(24)	32	4	M5-12 deep	–	(12)	12	21,5	0,50	0,15
25	40	40	16	7,5	48	48	(34)	37	5,5	M5-13 deep	–	33 (12)	7	17	0,80	0,20
32	52	52	20	10	60	60	(42,5)	47	6,5	M6-17 deep	–	40 (12)	8	20	1,60	0,35
40	65	65	20	10	75	75	(49,5)	58	8,5	M8-20 deep	–	50 (12)	8	25	2,70	0,50
50	80	80	25	13	90	90	(58,5)	70	10	M8-18 deep	–	60 (17)	11	30	4,80	0,75
63	95	95	25	14	105	105	(68)	84	10,5	M10-24 deep	–	70 (20)	11	35	7,20	1,00
80	120	120	29	–	130	130	(81)	100	15	M12-26 deep	11	90 (25)	15	40	13,20	1,50

() for external guided.

Mounting

Foot mounting – C

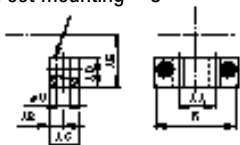

Ø	AA	AB	AC	AD	AE	R	ØU	kg
20	17	5	10	10	21,5	40	5,5	0,03
25	18	7	15	13,5	24	48	7	0,01
32	26	11	22	16,5	30,5	60	9	0,1
40	30	11	22	19,5	37,5	75	9	0,2
50	42	12	25	24	45	90	11	0,3
63	48	13	25	27,5	54	105	13	0,4
80	64	12,5	25	35	70	130	14	0,4

Centre support – V

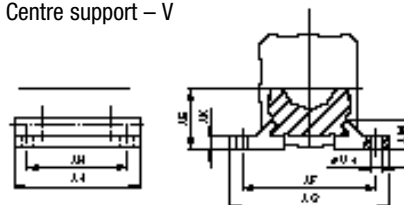

Ø	AE	AF	AG	AH	AJ	AK	AM	ØU1	kg
20	21,5	52	62	45	60	4,5	12	5,5	0,03
25	24	60	72	60	80	5,5	13	6,6	0,04
32	30,5	76	92	70	100	6,5	18,5	9	0,07
40	37,5	92	108	90	120	7,5	18,5	9	0,2
50	45	110	128	110	140	7,5	18,5	11	0,2
63	54	132	154	120	160	9	25	13	0,3
80	70	155	180	140	180	12	28,5	14	0,4

Serviceable air bellows Stainless steel

KM/31000

Single acting

Ø 8 to 14½"

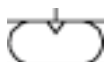

High corrosion and acid resistant materials

Frictionless operation

No maintenance or lubrication

Ideal for short stroke, high-force applications

High isolation level for vibrating machines

Very easy to install – no alignment problems

Technical data

Medium:

Compressed air, non-lubricated

Operation:

Single acting

Operating pressure:

8 bar max.

Operating temperature:

-40°C to +70°C for KM/31000

(Standard)

-25°C to +90°C for TKM/31000 (Butyl)

-20°C to +115°C for EKM/31000

(Epichlore)

Consult our Technical Service for use below +2°C

Strokes:

80 to 380 mm max., depending on diameter and number of convolutions.

Materials

End plates, fixing studs and central ring: stainless steel 1.4301

Rubber part: fabric reinforced NR-, SBR- and BR compound rubber (KM/31000), fabric reinforced butyl (TKM/31000), fabric reinforced Epichlore (EKM/31000)

Important note: The design of these air bellows allows an operation at an angle of 5° to 25°. The top and bottom plate can be out of alignment, depending on the height of the air bellows and the number of convolutions. To avoid damage, mechanical stops at both end positions have to be used. To return air bellows to their minimum height an external return force must be used. The thrust depends directly on the height of the air bellows: when height increases, the thrust decreases. As the outside diameter varies in operation there must be enough clearance around the air bellows.



Standard models

Model	Nominal Ø (inch) x convolutions	Maximum stroke (mm)	Port size
KM/31081	8 x 1	80	G1/2
KM/31082	8 x 2	175	G1/2
KM/31101	10 x 1	100	G1/2
KM/31102	10 x 2	225	G1/2
KM/31103	10 x 3	330	G1/2
KM/31121	12 x 1	100	G1/2
KM/31122	12 x 2	225	G1/2
KM/31123	12 x 3	330	G1/2
KM/31141	14½ x 1	125	G1/2
KM/31142	14½ x 2	265	G1/2
KM/31143	14½ x 3	380	G1/2

Options selector

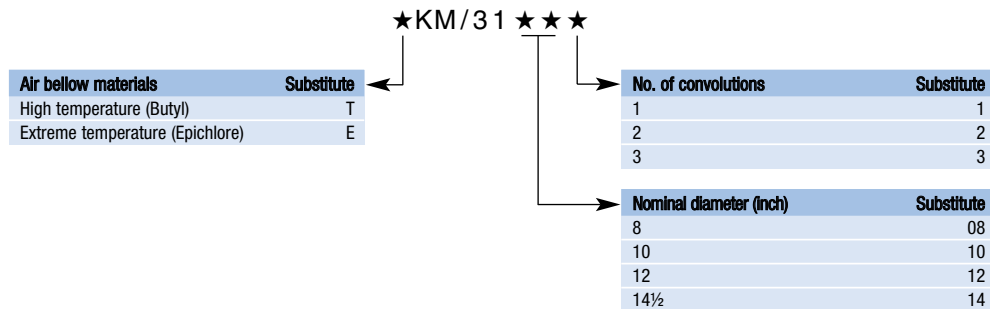

Note: disregard option positions not used.

Safety note: These actuators must not be pressurised when unrestrained.
For exact calculation for compact air bellows please contact our Technical Service.

Serviceable air bellows Stainless steel

KM/31000

Single acting

Ø 8 to 14½"

KM/31000 Stainless steel – standard serviceable air bellows

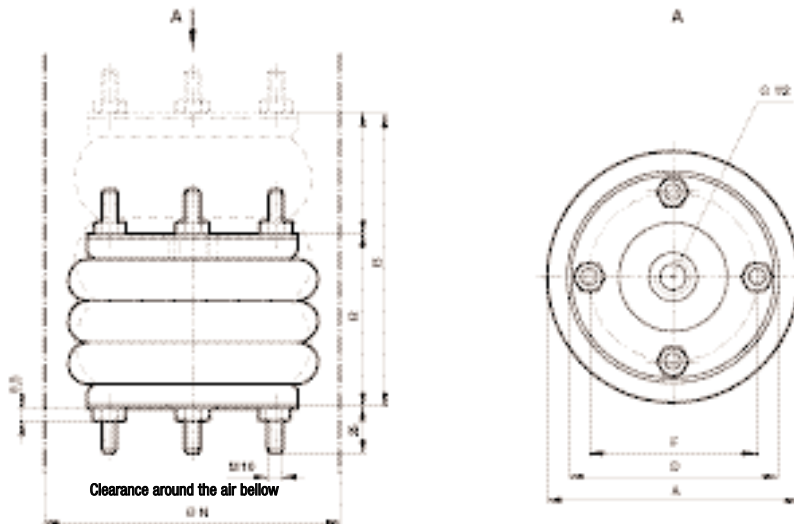

Model	Installation height		Ø A	Ø D	Ø F	Ø N	kg
	B min. (mm)	B max. (mm)					
KM/31081	50	130	230	184	155,5	245	6,4
KM/31082	75	250	220	184	155,5	245	7,3
KM/31101	50	150	280	210	181	300	8,5
KM/31102	75	300	270	210	181	300	9,7
KM/31103	100	430	270	210	181	300	10,9
KM/31121	50	150	330	260	232	350	13,2
KM/31122	75	300	325	260	232	350	14,8
KM/31123	100	430	325	260	232	350	16,3
KM/31141	50	175	395	310	282,5	425	18,6
KM/31142	75	340	400	310	282,5	425	19,6
KM/31143	100	480	400	310	282,5	425	20,5

Ported stainless steel equipment

Filters, pressure regulators, lubricators

F22, R22, L22

1/2" PTF

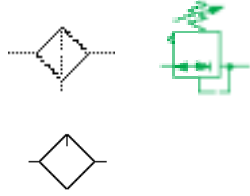

Lloyds Register Type Approved

Materials meet NACE* recommendations (MR-0175, 2002 revision)

25 µm filter element and auto drain as standard

Orientable metal bowls with sightglasses

* National Association of Corrosion Engineers – recognised oil-field recommendation for resistance to sulphide stress cracking common in well-head and other corrosive environments

Technical data

Medium:

Compressed air only

Maximum inlet pressure:

17 bar (F22, L22)

20 bar (R22)

Gauge ports:

1/4 PTF (R22)

Start point:

1,7 dm³/s @ 6,3 bar (L22)

Ambient temperature:

-20°C to +80°C

Consult our Technical Service for use below +2°C

Materials

Bowl, bonnet & adjusting screw: stainless steel

Elastomers: synthetic rubber

Filter element: sintered stainless steel, polyethylene (option of stainless steel)

Alternative models

5 µm element

Pressure ranges

Non-relieving versions

Contact our Technical Service for details

Filters

Port size	Flow (dm ³ /s)*	Element (µm)	Drain	Bowl	kg	Model	Service kit
1/2 PTF	57	25	Auto	Metal	1,88	F22-400-A2DA	F22-100A
1/2 PTF	57	25	Manual	Metal	1,84	F22-400-M2DA	F22-100M

* Maximum flow with 6,3 bar inlet pressure and pressure drop of 0,5 bar.

Pressure regulators

Port size	Flow (dm ³ /s)*	Range (bar)	Operation	kg	Model	Service kit
1/2 PTF	50	0,4 ... 10	Relieving	1,52	R22-401-RNMA	R22-100R
1/2 PTF	50	0,4 ... 10	Non-relieving	1,54	R22-401-NNMA	R22-100NR

*Can be adjusted to zero bar outlet pressure, and, generally to pressures in excess of those specified.

Maximum flow with 10 bar inlet pressure, 6,3 bar outlet pressure and a pressure drop of 1 bar from set.

Lubricators



Port size	Flow (dm ³ /s) #	Start point (dm ³ /s)‡	Operation	Bowl	Bowl capacity	kg	Model *	Service kit
1/2 PTF	48	1,7	Oil-fog	Metal	0,2 l	1,93	L22-400-OP8A	L22-100

#Typical flow with 6,3 bar inlet pressure and 0,5 bar pressure drop.

* Models listed in the order table must not be located downstream of frequently cycling directional control valves. Order the optional bi-directional oil-fog lubricator for use under such conditions.

‡ Start point at 6,3 bar.

Accessories

Series	Bracket kit	Gauge (0 ... 10 bar)#	Neck mounting bracket
			
F22	18-001-962		
R22	18-001-962	18-013-909*	18-001-959 (Panel nut and single bracket)
L22	18-001-962		

Other pressure ranges available.

* Stainless steel items not strictly to NACE standard MR-01-75.

Ported stainless steel equipment

Filters, pressure regulators, lubricators

F22, R22, L22

1/2" PTF

F22

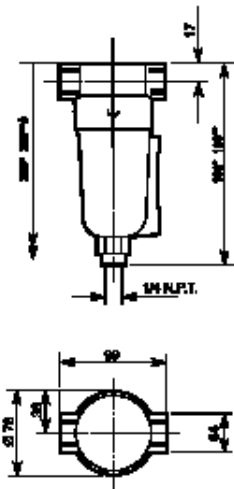

Weight: 1,88 kg
 *Auto **Manual
 # Minimum clearance required to remove bowl from body

Bracket mounting (F22)

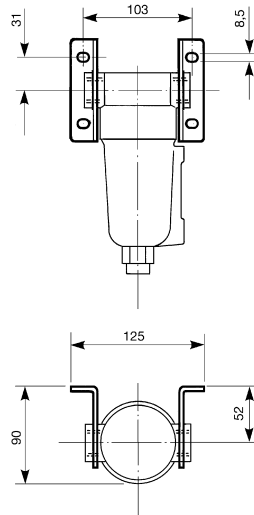

Flow characteristics

F22

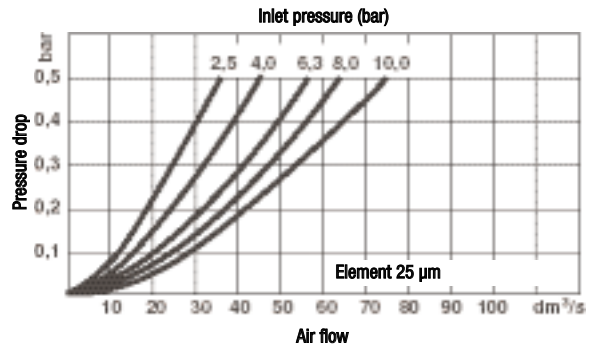

R22

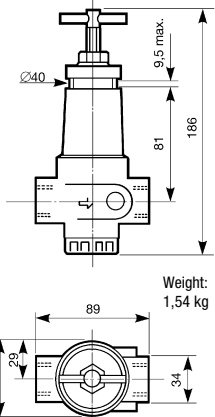

Weight: 1,54 kg

Bracket mounting (R22)

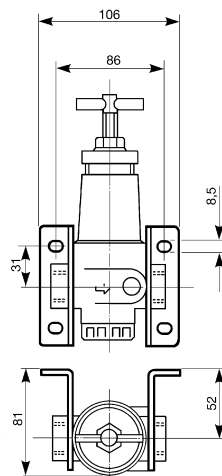

R22

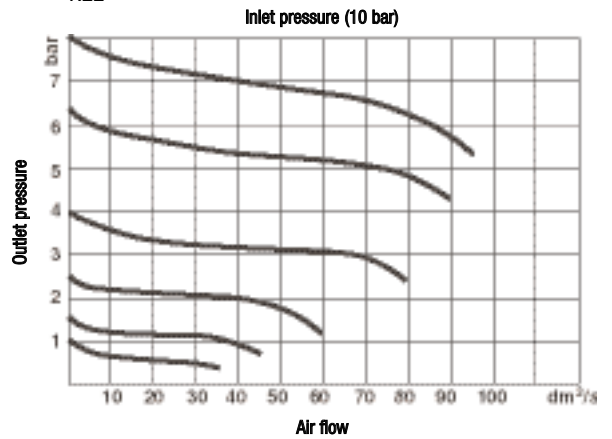

L22

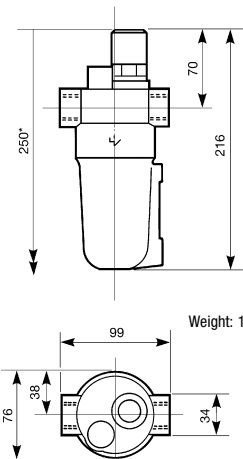

Weight: 1,93 kg

Bracket mounting (L22)

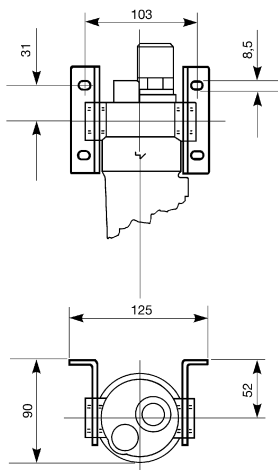

L22

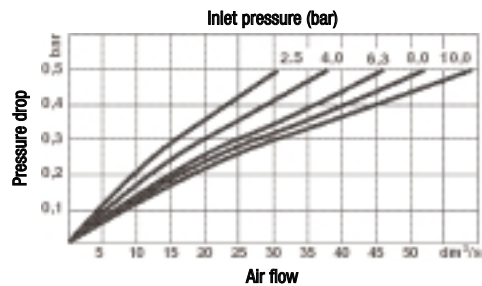

Precision stainless steel regulators

Pressure regulators, filter-regulators

R38, B38

¼" PTF, ½" PTF (B38)

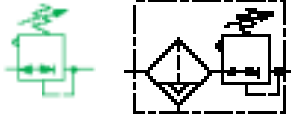

R38 and B38 Lloyds Register Type Approved

Materials meet NACE* recommendations (MR-0175, 2002 revision)

Suitable for marine, offshore, food processing and dental applications

R38/B38 models for precision regulation and high flow rates

* National Association of Corrosion Engineers – recognised oil-field recommendation for resistance to sulphide stress cracking common in well-head and other corrosive environments

Technical data

Medium:

Compressed air only

Maximum inlet pressure:

17 bar (autodrain)

31 bar (R38, B38 manual drain)

Gauge ports:

1/4 PTF (R38, B38)

Ambient temperature:

-40°C to +80°C (R38, B38)

Consult our Technical Service for use below +2°C

Materials

Body, bowl, bonnet & adjusting screw: stainless steel

Elastomers: synthetic rubber

Filter element: high density polyethylene (25 µm), ceramic pyrolith (5 µm) (B38)

Alternative models

5 µm element

Pressure ranges

Non-relieving versions

Viton elastomers

Contact our Technical Service for details



R38

B38

Precision regulators

Port size	Flow (dm³/s)*	Range (bar)	Operation	kg	Model	Service kit
1/4 PTF	8	0,04 ... 2	Relieving	0,48	R38-240-RNCA	R38-100R
1/4 PTF	8	0,07 ... 4	Relieving	0,46	R38-240-RNFA	R38-101R

* Typical flow with 7 bar inlet pressure, 6,3 bar set pressure and a droop of 1 bar

Precision filter-regulators

Port size	Flow (dm³/s)	Element (µm)	Drain	Range (bar)	Operation	kg	Model	Service kit
1/4 PTF	8*	25	Manual	0,25 ... 7	Relieving	1,40	B38-244-B2KA	R38-101R & B38-100S (25)
1/4 PTF	8*	25	Manual	0,07 ... 4	Relieving	1,40	B38-244-B2FA	R38-101R & B38-100S (25)
1/4 PTF	8*	25	Auto	0,07 ... 4	Relieving	1,60	B38-244-A2FA	R38-101R & B38-100S (25)
1/2 PTF	50**	25	Manual	0,3 ... 9	Relieving	1,40	B38-444-M2LA #	2787-41 & 2787-44
1/2 PTF	50**	25	Auto	0,3 ... 9	Relieving	2,10	B38-444-A2LA ‡	2787-41 & 2787-44

Can be adjusted to zero outlet pressure, and, generally, to pressures in excess of those specified.

* Typical flow with 7 bar inlet pressure, 1 bar set pressure and a droop of 0,05 bar.

** Typical flow with 12 bar inlet pressure, 8 bar set pressure and a droop of 1 bar.

Drain kits:

Manual drain 2787-43

‡ Auto drain 3000-87

Options selector

Port size	Substitute	Thread	Substitute
1/4	2	PTF	A
1/2	4	ISO RC Taper	B
		ISO G Parallel	D
Diaphragm	Substitute	Outlet pressure adjustment range*	Substitute
Relieving with panel nut	4	0,04 ... 2	C
Non relieving with panel nut	5	0,07 ... 4	F
		0,25 ... 7	K#
		0,50 ... 10	M
		0,3 ... 9	L‡
Drain	Substitute		
Automatic	A		
Manual – short bowl	B		
Manual – long bowl	M		
Element	Substitute		
5 µm	1		
25 µm	2		

* Outlet pressure can be adjusted to pressures in excess of, and less than, those specified. Do not use these units to control pressures outside of the specified ranges.

1/4" only. ‡ 1/2" only

Precision stainless steel regulators

Pressure regulators, filter-regulators

R38, B38

¼" PTF, ½" PTF (B38)

Accessories

Series	Neck mounting bracket	Gauge (0 ... 10 bar)#	Panel mounting	Plastic adjusting knob
R38	18-001-973 (includes panel nut)	18-013-913*	5988-02 (Nut only)	74630-04
B38	18-001-973 (includes panel nut)	18-013-913*	5988-02 (Nut only)	74630-04

Other pressure ranges available.

* Stainless steel items not strictly to NACE standard MR-01-75

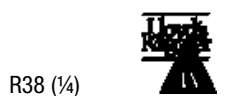

R38 (¼)



Weight: 0,48 kg

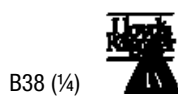

B38 (¼)

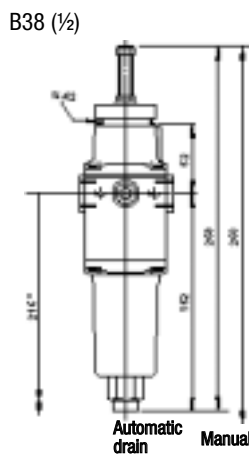
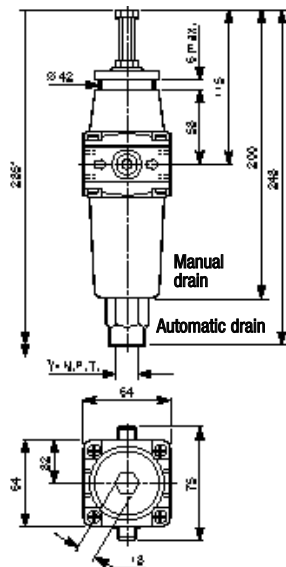

B38 (½)

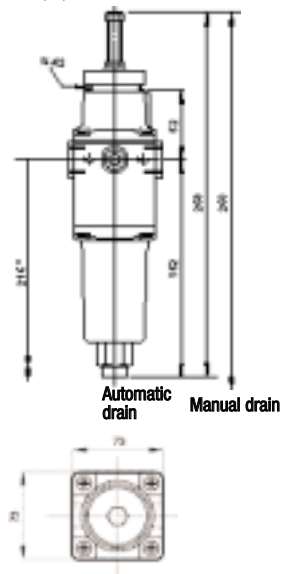

Bracket mounting (R38, B38)

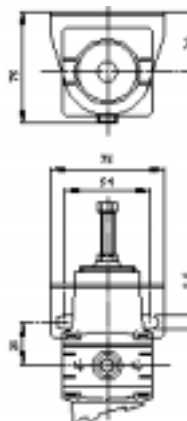

Flow characteristics

R38/B38, 1/4"

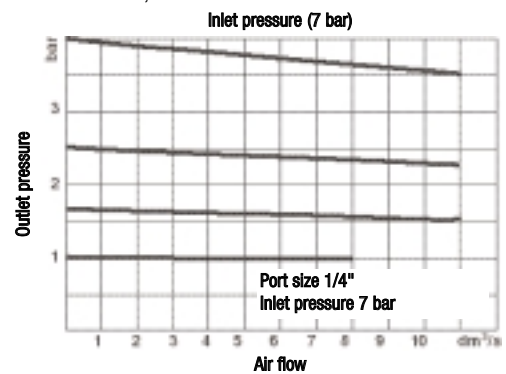

B38, 1/2"

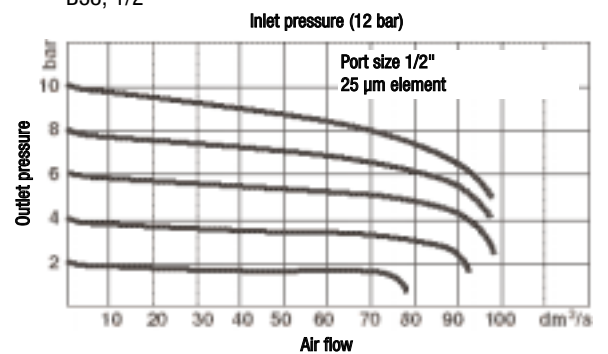

Stainless steel push-in tube fittings

Metric

Ø 4 to 12 mm O/D tube

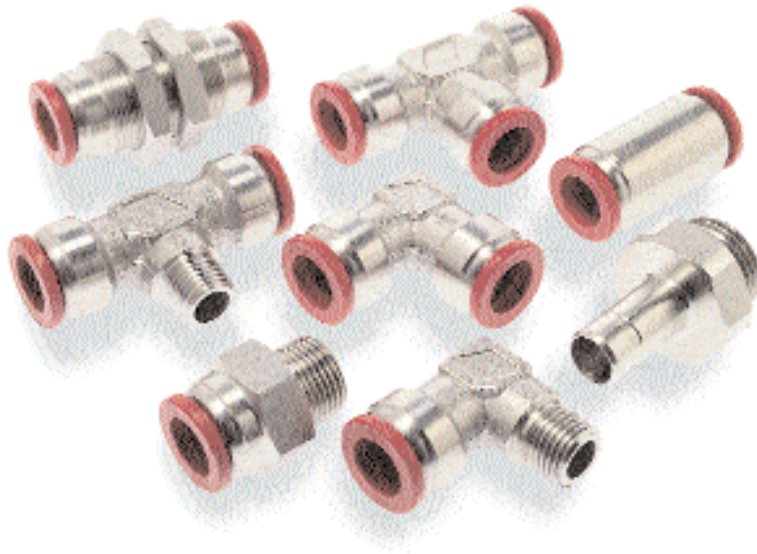

Resistant to aggressive environments

Suitable for food applications

Stainless steel

Very compact

Corporate red food grade release sleeve

Allows easy leak free installation

Easy tube insertion and removal

'O'ring sealing on parallel threads

Compatible with range of tubing

Full bore no flow restrictions

Technical data

Medium:

Compressed air or water

Operating pressure:

Vacuum - 18 bar

Vacuum - 750mm of Hg

ie. 98%

Ambient temperature:

Air -20°C to +110°C

Water 0°C to +110°C

Materials

Body: stainless steel 316

Grab ring: stainless steel 316

Release sleeve: acetal

'O'ring: Viton

Alternative models

61 Series ball valves

Filters pressure regulators and lubricators

Roundline, tie-rod and rodless cylinders

Air bellows

Tube sizes

4, 6, 8, 10 and 12 mm O/D

Tube types

Nylon 11 or 12, polyurethane and PTFE

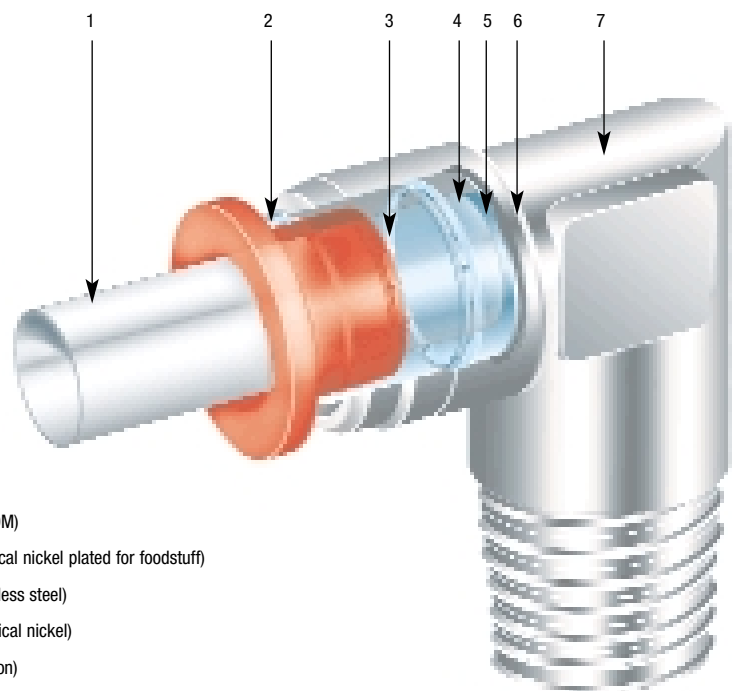

- 1 Pipe
- 2 Release sleeve (POM)
- 3 Ring (OT.58 chemical nickel plated for foodstuff)
- 4 Locking ring (stainless steel)
- 5 Bush (OT.58 chemical nickel)
- 6 Internal O-ring (Viton)
- 7 Body (AISI 3 1 6)

Stainless steel push-in tube fittings

Metric

Ø 4 to 12 mm O/D tube



Straight connector

O/D Tube	
4	S00200400
6	S00200600
8	S00200800
10	S00201000
12	S00201200



Tee connector

O/D Tube	
4	S00600400
6	S00600600
8	S00600800
10	S00601000
12	S00601200



Straight adaptor

O/D Tube	BSPP Thread	
4	1/8	S02250418
6	1/8	S02250618
6	1/4	S02250628
8	1/8	S02250818
8	1/4	S02250828
10	1/4	S02251028
10	3/8	S02251038
12	1/4	S02251228
12	3/8	S02251238
12	1/2	S02251248



Tee adaptor

O/D Tube	BSPT Thread	
4	R1/8	S01650418
6	R1/8	S01650618
6	R1/4	S01650628
8	R1/4	S01650828
10	R1/4	S01651028
12	R1/4	S01651228
12	R3/8	S01651238



Elbow adaptor

O/D Tube	BSPP Thread	
4	R1/8	S01450418
6	R1/8	S01450618
6	R1/4	S01450628
8	R1/8	S01450818
8	R1/4	S01450828
10	R1/4	S01451028
12	R1/4	S01451228



Unequal stem connector

O/D Stem	O/D Tube	
6	4	S00230604
8	4	S00230804
8	6	S00230806
10	6	S00231006
10	8	S00231008
12	6	S00231206
12	8	S00231208
12	10	S00231210



Straight adaptor

O/D Tube	BSPT Thread	
4	R1/8	S01250418
6	R1/8	S01250618
6	R1/4	S01250628
8	R1/8	S01250818
8	R1/4	S01250828
10	R1/4	S01251028
10	R3/8	S01251038
12	R1/4	S01251228
12	R3/8	S01251238



Straight stem adaptor

O/D Stem	BSPP Thread	
4	G1/8A	S02150418
6	G1/8A	S02150618
8	G1/4A	S02150828
10	G1/4A	S02151028
12	G3/8A	S02151238
12	G1/2A	S02151248



Elbow connector

O/D Tube	
4	S00400400
6	S00400600
8	S00400800
10	S00401000
12	S00401200



Bulkhead connector

O/D Tube	
4	S00290400
6	S00290600
8	S00290800
10	S00291000
12	S00291200

61 Series ball valves

Stainless steel

¼" to 1" BSPP



Ideally suited for most industrial applications

Easy installation, simple operation and maintenance free

Full bore passage giving minimum flow resistance

Suitable for process, chemical or food industries

Lever or tee handle options

Technical data

Medium:

Compressed air, water, inert gases and any other fluid compatible with the valve materials

Operating pressure:
100 bar (1/4, 3/8, 1/2), 64 bar (3/4, 1)

Ambient temperature:
-20°C to 150°C

Materials

Body: stainless steel investment casting AISI 316

Stem: stainless steel AISI 316

Ball seats: virgin PTFE

Lower & upper stem packing: virgin PTFE

Static gasket: Virgin PTFE

Ball: stainless steel AISI 316

Viton 'O' rings

Lever handle: stainless steel AISI 304

End connection: stainless steel investment casting AISI 316

Stainless steel ball valves

Female BSPP	Maximum pressure (bar)	
1/4	100	615112128
3/8	100	615112138
1/2	100	615112148
3/4	64	615112168
1	64	615112188

Operating temperature: -20°C to +150°C

*To order 'Tee' handled version change 4th character to 2

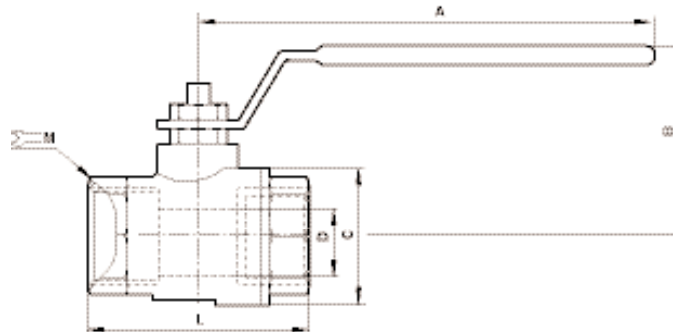

	A	B	C	D (t.bore)	L	M (a/f)
1/4	100	45	29	8	50	21
3/8	100	45	29	10	50	21
1/2	110	53,5	34	15	60	26
3/4	140	64	42,5	20	70	32
1	140	68	50,5	25	85	40